

2020



PROFESSIONAL WIRELESS SYSTEMS AND MICROPHONES
JUST TRUE SOUND

JTS®



Future-proof Wireless Microphone Systems from JTS

The wireless and microphone technology of the JTS brand offers you future-proof systems that guarantee trouble-free operation in the areas 506-542 MHz, 530-605 MHz and 863-865 MHz. The use of these transmission areas is subject to registration and fees throughout Europe. The JTS systems in the 863-865 MHz frequency range can be operated free of registration and fees.

For the respective legal regulations in the EU countries and non-European countries, please contact the responsible national authorities. In Germany this is the Federal Network Agency (www.bundesnetzagentur.de).

506-542 MHz

An interference-free use of this transmission range is ensured due to broadband Internet. However, a licence is required for use across Europe. The wide frequency range allows for a professional parallel operation of several systems and for a transmitting power of up to 50 mW.

863-865 MHz

In this transmission range, wireless microphone systems can be operated licence-free in the EU if their transmitting power does not exceed 10 mW. The 16-channel PLL audio transmission system for cameras as well as the tour guide system use this frequency range.

530-605 MHz

This transmission range enables the user to utilise a particularly wide bandwidth of 75 MHz. Thus, it allows to easily adapt the transmitter and receiver to local conditions. A licence is required for use of the frequency range 530-605 MHz across Europe. The wide frequency range allows for a professional parallel operation of several systems, for a transmitting power of up to 50 mW and for an interference-free use due to broadband Internet.

Contents

01 Pro Line	J2
02 Performer Line.....	J5
03 Impulse Line	J10
04 Go Line	J13
05 Accessories for Wireless Systems.....	J18
06 In-ear Monitoring Systems	J23
07 Headband Microphones and Lavalier Microphones	J26
08 Instrument Mics, Vocal Mics, Studio Mics and Headphones	J30
09 Universal Mics, Overhead Mics and Boundary Mics.....	J38
10 Gooseneck Mics, Microphone Floor Stands, Built-in Mics and Desktop Mics.....	J42
11 Accessories for Microphones	J47
12 Conference Systems, Microphone Mixers and Interpretation Systems.....	J51
13 Tour Guide Systems.....	J58
Index.....	J64
Important Information	J65

Adobe Stock: © Silhouette of an unrecognizable man singing rap, Cristian / people in the art gallery center, bluraz / Conference table closeup, peshkova / Behind the scenes of silhouette people working in big production studio with professional set and lighting for making movie film or video commercial, gnepphoto / Learning Acoustic Guitar, Tomasz Zajda / Presenter Presenting Presentation to Conference Audience. De-focused Blurred. Lecturer on Stage at Tech Forum. Speaker Giving Speech in Conference Hall Auditorium. Copy Space Screen Background., Right 3 / crowd at concert - summer music festival, Melinda Nagy / Pumping iron in the gym for bulking and weight building to get a bigger body. Male fitness routines and workout patterns with protein, Travis / successful businessman holds business conference for the press, yurolaitsalbert / Musical group in concert. Madrid, Spain., OscarStock / Skyline urbano con silhouette di antenne, Ipictures / Actors performers on stage and audience waiting for show to start in theater, disq / Microphone and cables, bizoo_n / Microphone for speaker speech with digits radio frequency transceiver or transmitter to show spectrum display wireless microphones receiver in conference hall or meeting room, smolaw11

All JTS products can also be found online at: www.jts-europe.com



Pro Line

The Pro Line from JTS delivers impressive performances in the fields of AV, broadcast as well as on theatre stages and concert stages. Audio professionals are impressed by the system which features a convenient setup function, REMOSET technology and a bandwidth of 75 MHz (530-605 MHz) as well as 3,000 freely selectable frequencies.

Broadcast | Live Performance

01

UF-20R/5

Order No. 0257210

**2-channel true diversity UHF PLL wideband receiver**

- Bandwidth: 75 MHz
- 15 groups, each with 63 compatible preset channels
- 64 channels in 6 groups from 3,000 selectable individual frequencies can be stored in user presets
- RF output and mains voltage output for easily cascading up to 10 x UF-20R/5 receiver without additional splitter
- REMOSET technology for receiver/transmitter synchronisation
- Auto-scan function
- Pilot tone and noise squelch
- Equalizer function
- LED for indicating RF level and AF level
- Backlit display for indicating battery status of the transmitter, frequency setup, active antenna

Model	UF-20R/5
Description	wireless receiver
Carrier frequency range	530-605 MHz
Audio frequency range	50-18,000 Hz
THD	< 0.5%
Dynamic range	> 108 dB
Audio signal receiver	100 mV XLR, 100 mV jack
Power supply receiver	~ 100-240 V/50-60 Hz/25 VA
Dimensions receiver	480 x 44 x 214 mm
Weight receiver	2.9 kg
Connections receiver	2 x XLR, bal., 2 x 6.3 mm jack, bal.

- Metal housing
- Power supply for optional antenna booster UB-900I directly via antenna inputs

There are restrictions or requirements within the EU!

Please read the notes regarding wireless systems in the section "IMPORTANT INFORMATION"!

**UF-20S/5**

Order No. 0257220

Single-channel true diversity UHF PLL wideband receiver

- Bandwidth: 75 MHz
- 15 groups, each with up to 63 compatible preset channels
- 64 channels in 6 groups from 3,000 selectable individual frequencies can be stored in user presets
- REMOSET technology for receiver/transmitter synchronisation
- Auto-scan function
- Pilot tone and noise squelch
- Equalizer function
- LED for indicating RF level and AF level
- Backlit display for indicating battery status of the transmitter, frequency setup, active antenna
- Metal housing
- Power supply for optional antenna booster UB-900I directly via antenna inputs

Model	UF-20S/5
Description	wireless receiver
Carrier frequency range	530-605 MHz
Audio frequency range	50-18,000 Hz
THD	< 0.5%
Dynamic range	> 108 dB
Audio signal receiver	100 mV XLR, 100 mV jack
Power supply receiver	via encl. power supply
Dimensions receiver	212 x 44 x 214 mm
Weight receiver	1.4 kg
Connections receiver	XLR, bal., 6.3 mm jack, bal.

There are restrictions or requirements within the EU!

Please read the notes regarding wireless systems in the section "IMPORTANT INFORMATION"!

**JSS-20/5**

Order No. 0257200

Dynamic hand-held UHF PLL transmitter

- Dynamic microphone cartridge (cardioid polar pattern) with minimised feedback susceptibility as well as suppression of handling noise/structure-borne noise
- Bandwidth: 75 MHz
- 15 groups, each with up to 63 compatible preset channels
- 64 channels in 6 groups from 3,000 selectable individual frequencies can be stored in user presets
- REMOSET technology for receiver/transmitter synchronisation
- Adjustable sensitivity (-15 dB to +15 dB)
- Lock function/mute function
- 5-level display for indicating battery status and low battery alert, backlit LCD

Model	JSS-20/5
Polar pattern	cardioid
System	dynamic
Carrier frequency range	530-605 MHz
Transmitting power	10/50 mW
Power supply	2 x batt. AA size, alkaline (not supplied)
Operating time	> 20 h
Audio frequency range	50-18,000 Hz
Dimensions	Ø 50 mm x 260 mm
Weight	340 g

- Switchable transmitting power
- Supplied with robust transport case, stand clamp and 8 ID caps

There are restrictions or requirements within the EU!

Please read the notes regarding wireless systems in the section "IMPORTANT INFORMATION"!



UF-20TB/5

Order No. 0257230

UHF PLL pocket transmitter

- Suitable for combination with a headband microphone or an instrument microphone with 4-pole mini XLR connector
- Bandwidth: 75 MHz
- 15 groups, each with up to 63 compatible preset channels
- 64 channels in 6 groups from 3,000 selectable individual frequencies can be stored in user presets
- REMOSET technology for receiver/transmitter synchronisation
- Adjustable sensitivity (-18 dB to +12 dB)
- Lock function
- 5-level display for indicating battery status and low battery alert, backlit LCD
- Switchable transmitting power

Model	UF-20TB/5
Description	pocket transmitter
Carrier frequency range	530-605 MHz
Audio frequency range	50-18,000 Hz
Operating time	> 20 h
Transmitting power	10/50 mW
Power supply transmitter	2 x batt. AA size (not supplied)
Dimensions transmitter	62 x 170 x 23 mm
Weight transmitter	90 g
Connections transmitter	4-pole mini XLR

There are restrictions or requirements within the EU!

Please read the notes regarding wireless systems in the section "IMPORTANT INFORMATION"!



CH-8

Order No. 0259410

Transport case with integrated charging function, for transmitters UF-20TB/5, JSS-20/5, JSS-4B/5, R-4TBM/5 and RU-G3TB/5.

- For simultaneously charging rech. batteries of 8 devices
- Average charging time, depending on capacity and condition of rechargeable batteries used: approx. 3 hours
- Each slot with LED for indicating a fault and battery charging status
- Mechanical reverse polarity protection
- Protection against overload, short-circuit and deep discharge
- Power is provided via supplied power supply
- Dimensions: 357 x 294 x 433 mm

Supplied w/o devices.

Model	CH-8
Description	transport case with integrated charging function
Colour	black
Suitable for	transmitters UF-20TB/5, JSS-20/5, JSS-4B/5, R-4TBM/5, RU-G3TB/5
Power supply	via encl. power supply
Dimensions	357 x 294 x 433 mm
Weight	11.6 kg



CH-2

Order No. 0257240

Charging station, for transmitters UF-20TB/5, JSS-20/5, JSS-4B/5, R-4TBM/5 and RU-G3TB/5.

- For simultaneously charging rech. batteries of 2 devices
- Average charging time, depending on condition of rechargeable batteries used: approx. 3 hours
- Each slot with LED for indicating a fault and battery charging status
- Mechanical reverse polarity protection

Model	CH-2
Description	charging station
Colour	black
Suitable for	transmitters UF-20TB/5, JSS-20/5, JSS-4B/5, R-4TBM/5, RU-G3TB/5
Power supply	via enclosed power supply
Dimensions	165 x 72 x 99 mm
Weight	315 g

- Protection against overload, short-circuit and deep discharge
- Power is provided via enclosed power supply
- Dimensions: 165 x 72 x 99 mm



MA-935

Order No. 0236850

Adapter ring

- For mounting dynamic microphone cartridges from Sennheiser to hand-held UHF PLL transmitters JSS-20/5 and JSS-4B/5
- Aluminium version
- Screw thread





Performer Line

Equipped with the latest wireless technology from JTS, the systems from the Performer Line provide convenient solutions for professional live applications. They feature impressive configuration options.

Broadcast | Live Performance

02

R-4/5

Order No. 0259400



4-channel diversity UHF PLL wideband receiver

- Bandwidth: 36 MHz
- 6 groups, each with up to 22 compatible preset channels
- 1,441 selectable individual frequencies
- RF output and mains voltage output for easily cascading up to 10 x R-4/5 receiver without additional splitter
- REMOSET technology for receiver/transmitter synchronisation
- Auto-scan function
- Pilot tone squelch and noise mute
- LED for indicating RF level and AF level
- Backlit display for indicating battery status of the transmitter, frequency setup, active antenna
- Switchable mic/line for single outputs and mixed outputs
- Metal housing

Model	R-4/5
Description	wireless receiver
Carrier frequency range	506-542 MHz
Audio frequency range	50-18,000 Hz
THD	< 0.6%
Dynamic range	> 105 dB
Audio signal receiver	630 mV/600 Ω XLR (line), 63 mV/600 Ω XLR (mic), 320 mV/600 Ω jack
Power supply receiver	~ 100-240 V/50-60 Hz
Dimensions receiver	485 x 44 x 230 mm
Weight receiver	2.65 kg
Connections receiver	4 x XLR, bal., 1 x XLR, bal., 1 x 6.3 mm jack (mixed out)



There are restrictions or requirements within the EU!

Please read the notes regarding wireless systems in the section "IMPORTANT INFORMATION"!

JSS-4B/5

Order No. 0259390

Dynamic hand-held UHF PLL transmitter

- Dynamic microphone cartridge (cardioid polar pattern) with wide dynamic range
- Aluminium housing
- Bandwidth: 36 MHz
- 6 groups, each with up to 22 compatible preset channels
- 1,441 selectable individual frequencies
- REMOSET technology for receiver/transmitter synchronisation
- Adjustable sensitivity (-15 dB to +15 dB)
- Lock/mute function
- 4-level display for indicating battery status and low battery alert, backlit LCD
- Switchable transmitting power

Model	JSS-4B/5
Transmission method	wireless
Polar pattern	cardioid
System	dynamic
Carrier frequency range	506-542 MHz
Transmitting power	10/50 mW
Power supply	2 x batt. AA size, alkaline (not supplied)
Operating time	> 20 h
Audio frequency range	50-18,000 Hz
Max. sound pressure	150 dB
Housing material	aluminium
Dimensions	Ø 50 mm x 253 mm
Weight	335 g



There are restrictions or requirements within the EU!

Please read the notes regarding wireless systems in the section "IMPORTANT INFORMATION"!

R-4THA/5

Order No. 0259847

Hand-held UHF PLL transmitter, with condenser cartridge.

- Condenser microphone cartridge (cardioid polar pattern)
- Bandwidth: 36 MHz
- 6 groups, each with up to 22 compatible preset channels
- 1,441 selectable individual frequencies
- REMOSET technology for receiver/transmitter synchronisation
- Adjustable sensitivity (± 15 dB)
- Lock function/mute function
- 4-level display for indicating battery status and low battery alert, backlit LCD
- Switchable transmitting power

Model	R-4THA/5
Transmission method	wireless
Polar pattern	cardioid
System	condenser
Carrier frequency range	506-542 MHz
Transmitting power	10/50 mW
Power supply	2 x batt. AA size, alkaline (not supplied)
Operating time	> 20 h
Audio frequency range	50-18,000 Hz
Max. sound pressure	140 dB
Dimensions	Ø 50 mm x 253 mm
Weight	260 g



There are restrictions or requirements within the EU!

Please read the notes regarding wireless systems in the section "IMPORTANT INFORMATION"!

R-4TBM/5

Order No. 0259841

UHF PLL pocket transmitter

- Suitable for combination with a headband microphone or an instrument microphone with 4-pole mini XLR connector
- Bandwidth: 36 MHz
- 6 groups, each with up to 22 compatible preset channels
- 1,441 selectable individual frequencies
- REMOSET technology for receiver/transmitter synchronisation
- Adjustable sensitivity (± 15 dB)
- Lock function
- 6-level display for indicating battery status and low battery alert, backlit LCD
- Switchable transmitting power

Model	R-4TBM/5
Description	pocket transmitter
Carrier frequency range	506-542 MHz
Audio frequency range	50-18,000 Hz
Operating time	> 20 h
Transmitting power	10/50 mW
Operating range	120 m
Power supply transmitter	2 x batt. AA size (not supplied)
Dimensions transmitter	62 x 80 x 23 mm
Weight transmitter	95 g
Connections transmitter	4-pole mini XLR

There are restrictions or requirements within the EU!

Please read the notes regarding wireless systems in the section "IMPORTANT INFORMATION"!



CH-2

Order No. 0257240

Charging station, for transmitters UF-20TB/5, JSS-20/5, JSS-4B/5, R-4TBM/5 and RU-G3TB/5.

- For simultaneously charging rech. batteries of 2 devices
- Average charging time, depending on condition of rechargeable batteries used: approx. 3 hours
- Each slot with LED for indicating a fault and battery charging status
- Mechanical reverse polarity protection
- Protection against overload, short-circuit and deep discharge
- Power is provided via enclosed power supply
- Dimensions: 165 x 72 x 99 mm

Model	CH-2
Description	charging station
Colour	black
Suitable for	transmitters UF-20TB/5, JSS-20/5, JSS-4B/5, R-4TBM/5, RU-G3TB/5
Power supply	via enclosed power supply
Dimensions	165 x 72 x 99 mm
Weight	315 g



RU-901G3/5

Order No. 0259844

True diversity UHF PLL wideband receiver

- Bandwidth: 36 MHz
- 6 groups, each with up to 22 compatible preset channels
- 1,441 selectable individual frequencies
- REMOSET ULTRASONIC technology for receiver/transmitter synchronisation
- Removable antennas (BNC connection)
- Auto-scan function
- Pilot tone squelch and noise mute
- LED for indicating RF level and AF level
- Backlit display with status indications, e.g. group/channel, frequency, battery, antenna A/B

Model	RU-901G3/5
Description	receiver unit
Carrier frequency range	506-542 MHz
Audio frequency range	50-18,000 Hz
THD	< 0.6%
Dynamic range	105 dB
Audio signal receiver	630 mV/600 Ω XLR (line), 63 mV/600 Ω XLR (mic), 320 mV/600 Ω jack
Power supply receiver	via encl. power supply
Dimensions receiver	212 x 38 x 144 mm
Weight receiver	1.02 kg
Connections receiver	1 x XLR, bal., 1 x 6.3 mm jack, unbal.

There are restrictions or requirements within the EU!

Please read the notes regarding wireless systems in the section "IMPORTANT INFORMATION"!



RU-G3TH/5

Order No. 0259843

Hand-held UHF PLL transmitter with condenser cartridge

- Bandwidth: 36 MHz
- 6 groups, each with up to 22 compatible preset channels
- 1,441 selectable individual frequencies
- REMOSET ULTRASONIC technology for receiver/transmitter synchronisation
- Pilot tone squelch and noise mute
- Lock function/mute function
- Special design to reduce handling noise, structure-borne noise and acoustic feedback
- Backlit LCD for indicating batt. status and low batt. alert
- Switchable transmitting power

Model	RU-G3TH/5
Transmission method	wireless
Polar pattern	cardioid
System	condenser
Carrier frequency range	506-542 MHz
Transmitting power	10/50 mW
Power supply	2 x batt. AA size, alkaline (not supplied)
Audio frequency range	50-18,000 Hz
Max. sound pressure	140 dB
Dimensions	Ø 50 mm x 253 mm
Weight	780 g

There are restrictions or requirements within the EU!

Please read the notes regarding wireless systems in the section "IMPORTANT INFORMATION"!



RU-G3TB/5

Order No. 0259842

UHF PLL pocket transmitter

- Suitable for combination with a headband microphone or an instrument microphone with 4-pole mini XLR connector
- Bandwidth: 36 MHz
- 6 groups, each with up to 22 compatible preset channels
- 1,441 selectable individual frequencies
- REMOSET ULTRASONIC technology for receiver/transmitter synchronisation
- Backlit LCD for indicating battery status and low battery alert
- Switchable transmitting power

Model	RU-G3TB/5
Description	pocket transmitter
Carrier frequency range	506-542 MHz
Audio frequency range	50-18,000 Hz
Operating time	12 h
Transmitting power	10/50 mW
Power supply transmitter	2 x battery AA size, alkaline (not supplied)
Dimensions transmitter	62 x 80 x 23 mm
Weight transmitter	300 g
Connections transmitter	4-pole mini XLR

There are restrictions or requirements within the EU!

Please read the notes regarding wireless systems in the section "IMPORTANT INFORMATION"!



G3CH-2

Order No. 0259839

Charging station, for transmitters RU-G3TH/5, RU-G3TB/5, R-4TBM/5 and UF-20TB/5.

- For simultaneously charging rech. batteries of 2 devices
- Average charging time, depending on condition of rechargeable batteries used: approx. 5 hours
- Each slot with LED for indicating a fault and battery charging status
- Mechanical reverse polarity protection

Model	G3CH-2
Description	charging station
Colour	black
Suitable for	transmitters RU-G3TH/5, RU-G3TB/5, R-4TBM/5, UF-20TB/5
Power supply	via encl. power supply
Dimensions	165 x 72 x 99 mm
Weight	323 g

- Protection against overload, short-circuit and deep discharge

- Power is provided via enclosed power supply

- Dimensions: 165 x 72 x 99 mm

Supplied w/o devices



US-903DCPRO/5

Order No. 0255570

2-channel diversity UHF PLL receiver

- 2 x 64 channel presets in four groups
- Parallel operation of up to 8 frequencies (equivalent to 4 x 2-channel system)
- Pilot tone squelch and adjustable noise squelch
- Lock function
- Backlit LCD for indicating status, e.g. for channel/group assignment and RF level/AF level
- Integrated charging slot for 4 x rechargeable NiMH battery AA size with indication of operating status
- Robust desktop metal housing
- Power supply for optional antenna booster UB-9001 directly via antenna inputs
- 482 mm (19") rack installation with supplied mounting brackets

Model	US-903DCPRO/5
Description	receiver unit
Carrier frequency range	518-542 MHz
Audio frequency range	40-18,000 Hz
THD	< 0.6%
Dynamic range	> 105 dB
Audio signal receiver	40 mV XLR, 250 mV jack
Power supply receiver	via encl. power supply
Dimensions receiver	420 x 50 x 230 mm
Weight receiver	2.25 kg
Connections receiver	2 x XLR, bal. 1 x 6.3 mm jack, unbal.

There are restrictions or requirements within in the EU!
Please read the notes regarding wireless systems in the section "IMPORTANT INFORMATION"!



MH-8800G/5

Order No. 0255450

Dynamic hand-held UHF PLL transmitter

- Preset technology for easy configuration (64 channels)
- Pilot tone technology
- Adjustable sensitivity (0 dB to -30 dB)
- Lock function
- Special design to reduce handling noise, structure-borne noise and acoustic feedback
- Robust body
- Integrated LCD with battery status indication
- Supplied with robust transport case, colour-coded ID rings and stand clamp

Model	MH-8800G/5
Polar pattern	hypercardioid
System	dynamic
Carrier frequency range	518-542 MHz
Transmitting power	10 mW
Power supply	2 x batt. AA size, alkaline (not supplied)
Operating time	> 25 h
Audio frequency range	50-16,000 Hz
Dimensions	Ø 53 mm x 245 mm
Weight	370 g

There are restrictions or requirements within in the EU!
Please read the notes regarding wireless systems in the section "IMPORTANT INFORMATION"!



PT-920BG/5

Order No. 0255490

UHF PLL pocket transmitter with lavalier microphone

- Suitable for instrument microphones of the CX series and headband microphones or lavalier microphones from the CX/CM series
- Supplied with lavalier microphone CM-501
- 64 preset channels
- Pilot tone technology
- Continuously adjustable gain
- Lock function
- Integrated LCD for indicating battery status and transmission data
- Supplied with belt bag and robust transport case

Model	PT-920BG/5
Description	pocket transmitter
Carrier frequency range	518-542 MHz
Audio frequency range	40-18,000 Hz
Operating time	> 30 h
Transmitting power	10 mW
Power supply transmitter	2 x batt. AA size, alkaline (not supplied)
Dimensions transmitter	70 x 190 x 30 mm
Weight transmitter	130 g
Connections transmitter	4-pole mini XLR

There are restrictions or requirements within in the EU!
Please read the notes regarding wireless systems in the section "IMPORTANT INFORMATION"!





Impulse Line

The systems of the Impulse Line provide a reliable operation in the frequency range 506-542 MHz and are perfectly suitable for a clear voice reproduction with high speech intelligibility at conferences, presentations, in schools, museums or sports facilities.

Conferences | Voice Transmission | Presentations

03

RU-8012DB/5

Order No. 0259420

2-channel diversity UHF PLL wideband receiver

- Bandwidth: 36 MHz
- 6 groups, each with up to 22 compatible preset channels
- 1,441 selectable individual frequencies
- REMOSET ULTRASONIC technology for receiver/transmitter synchronisation
- Removable antennas (BNC connection)
- Auto-scan function
- Pilot tone squelch and noise mute

There are restrictions or requirements within the EU!

Please read the notes regarding wireless systems in the section "IMPORTANT INFORMATION"!

Model	RU-8012DB/5
Description	receiver unit
Carrier frequency range	506-542 MHz
Audio frequency range	50-16,000 Hz
THD	< 0.6%
Dynamic range	> 105 dB
Audio signal receiver	630 mV/600 Ω XLR (line), 63 mV/600 Ω XLR (mic), 320 mV/600 Ω jack
Power supply receiver	via encl. power supply
Dimensions receiver	212 x 38 x 144 mm
Weight receiver	508 g
Connections receiver	2 x XLR, bal., 2 x 6.3 mm jack, unbal.



RU-8011DB/5

Order No. 0259200

Diversity UHF PLL wideband receiver

- Bandwidth: 36 MHz
- 6 groups, each with up to 22 compatible preset channels
- 1,441 selectable individual frequencies
- REMOSET ULTRASONIC technology for receiver/transmitter synchronisation
- Removable antennas (BNC connection)
- Auto-scan function
- Pilot tone squelch and noise mute

There are restrictions or requirements within the EU!

Please read the notes regarding wireless systems in the section "IMPORTANT INFORMATION"!

Model	RU-8011DB/5
Description	receiver unit
Carrier frequency range	506-542 MHz
Audio frequency range	50-16,000 Hz
THD	< 0.6%
Dynamic range	> 105 dB
Audio signal receiver	630 mV/600 Ω XLR (line), 63 mV/600 Ω XLR (mic), 320 mV/600 Ω jack
Power supply receiver	via encl. power supply
Dimensions receiver	212 x 38 x 144 mm
Weight receiver	457 g
Connections receiver	1 x XLR, bal., 1 x 6.3 mm jack, unbal.



RU-850LTH/5

Order No. 0259560

Dynamic hand-held UHF PLL microphone transmitter

- Bandwidth: 36 MHz
- 6 groups, each with up to 22 compatible preset channels
- 1,441 selectable individual frequencies
- REMOSET ULTRASONIC technology for receiver/transmitter synchronisation
- Lock function/mute function
- Special design to reduce handling noise, structure-borne noise and acoustic feedback
- 5-level display for indicating battery status and low battery alert, backlit LCD
- Switchable transmitting power

Model	RU-850LTH/5
Transmission method	wireless
Polar pattern	cardioid
System	dynamic
Carrier frequency range	506-542 MHz
Transmitting power	10/50 mW
Power supply	2 x batt. AA size, alkaline (not supplied)
Operating time	30 h
Audio frequency range	50-16,000 Hz
Max. sound pressure	148 dB
Dimensions	Ø 51 mm x 269 mm
Weight	242 g

There are restrictions or requirements within the EU!

Please read the notes regarding wireless systems in the section "IMPORTANT INFORMATION"!



RU-850LTB/5

Order No. 0259360

UHF PLL pocket transmitter

- Suitable for combination with a headband microphone or an instrument microphone with 4-pole mini XLR connector
- Bandwidth: 36 MHz
- 6 groups, each with up to 22 compatible preset channels
- 1,441 selectable individual frequencies
- REMOSET ULTRASONIC technology for receiver/transmitter synchronisation
- Adjustable sensitivity (± 15 dB)
- Lock function
- 5-level display for indicating battery status and low battery alert, backlit LCD
- Switchable transmitting power

Model	RU-850LTB/5
Description	pocket transmitter
Carrier frequency range	506-542 MHz
Audio frequency range	50-16,000 Hz
Operating time	30 h
Transmitting power	10/50 mW
Power supply transmitter	2 x batt. AA size, alkaline (not supplied)
Dimensions transmitter	62 x 97 x 20 mm
Weight transmitter	76 g
Connections transmitter	4-pole mini XLR

There are restrictions or requirements within the EU!

Please read the notes regarding wireless systems in the section "IMPORTANT INFORMATION"!



850CH-2

Order No. 0259370

Charging station, for transmitters RU-850LTH/5, RU-850LTB/5 and R-4THA/5.

- For simultaneously charging rech. batteries of 2 devices
- Average charging time, depending on condition of rechargeable batteries used: approx. 5 hours
- Each slot with LED for indicating a fault and battery charging status
- Mechanical reverse polarity protection
- Protection against overload, short-circuit and deep discharge
- Power is provided via enclosed power supply
- Dimensions: 165 x 72 x 99 mm

Supplied w/o devices.

Model	850CH-2
Description	charging station
Colour	black
Suitable for	transmitters RU-850LTH/5, RU-850LTB/5, R-4THA/5
Power supply	via encl. power supply
Dimensions	165 x 72 x 99 mm
Weight	329 g





Go Line

The robust and easy-to-use Go Line devices operate in the frequency range 863-865 MHz and should be part of any starter kit used in educational and sports facilities. They turn tutorials, lectures and presentations into successful events. The price-performance ratio is absolutely impressive.

Voice Transmission | Presentations

04

E-7DU/5

Order No. 0259616



2-channel diversity UHF PLL receiver

- 16 channels
- Removable antennas (BNC connection)
- Pilot squelch and noise mute
- 7-segment channel indicator
- LED indicators for RF signal and audio signal

There are restrictions or requirements within the EU!

Please read the notes regarding wireless systems in the section "IMPORTANT INFORMATION"!

Model	E-7DU/5
Description	receiver unit
Carrier frequency range	518-542 MHz
Audio frequency range	40-18,000 Hz
THD	< 0.6%
Dynamic range	> 100 dB
Audio signal receiver	180 mV jack
Power supply receiver	via encl. power supply
Dimensions receiver	221 x 40 x 152 mm
Connections receiver	1 x 6.3 mm jack, bal.



E-7R/5

Order No. 0259615



Diversity UHF PLL receiver

- 16 channels
- Removable antennas (BNC connection)
- Pilot tone squelch and noise mute
- 7-segment channel indicator
- LED display for indicating HF signal and audio signal

There are restrictions or requirements within the EU!

Please read the notes regarding wireless systems in the section "IMPORTANT INFORMATION"!

Model	E-7R/5
Description	receiver unit
Carrier frequency range	518-542 MHz
Audio frequency range	40-18,000 Hz
THD	< 0.6%
Dynamic range	> 100 dB
Audio signal receiver	180 mV jack
Power supply receiver	via encl. power supply
Dimensions receiver	221 x 40 x 152 mm
Connections receiver	1 x 6.3 mm jack, bal.



E-7TH/5

Order No. 0259618



E-7THD/5

Order No. 0259617



Dynamic hand-held UHF PLL transmitter

- 16 channels
 - Mute function
 - 7-segment channel indicator
 - LED indicators for power, battery status and mute
- E-7THD/5 = set of 2, suitable for the 2-channel UHF PLL receiver E-7DU/5**

Model	E-7TH/5, E-7THD/5
Polar pattern	hypercardioid
System	dynamic
Carrier frequency range	518-542 MHz
Transmitting power	10 mW
Power supply	2 x batt. AA size, alkaline (not supplied)
Audio frequency range	50-16,000 Hz

There are restrictions or requirements within the EU!

Please read the notes regarding wireless systems in the section "IMPORTANT INFORMATION"!



E-7TB/5

Order No. 0259621



E-7TBD/5

Order No. 0259619



UHF PLL pocket transmitter with lavalier microphone

- Suitable for instrument microphones of the CX series as well as headband microphones of the CX/CM series
 - Supplied with lavalier microphone CM-501
 - 16 channels
 - Mute function
 - 7-segment channel indicator
 - LED indicators for power, battery status and mute
- E-7TBD/5 = set of 2, suitable for the 2-channel UHF PLL receiver E-7DU/5**

Model	E-7TB/5, E-7TBD/5
Description	pocket transmitter
Carrier frequency range	518-542 MHz
Audio frequency range	40-18,000 Hz
Operating time	> 30 h
Transmitting power	10 mW
Power supply transmitter	2 x batt. AA size, alkaline (not supplied)
Connections transmitter	4-pole mini XLR

There are restrictions or requirements within the EU!

Please read the notes regarding wireless systems in the section "IMPORTANT INFORMATION"!



E-7HHSET/5

Order No. 0259614

**UHF PLL audio transmission set,**

consisting of:

- Diversity UHF PLL receiver E-7R/5
 - Dynamic hand-held UHF PLL transmitter E-7TH/5
- For specifications, please refer to the individual items.

There are restrictions or requirements within the EU!

Please read the notes regarding wireless systems in the section "IMPORTANT INFORMATION"!

**E-7HHSETD/5**

Order No. 0259613

**UHF PLL audio transmission set,**

consisting of:

- 2-channel diversity UHF PLL receiver E-7DU/5
 - Dynamic hand-held UHF PLL transmitter (set of 2) E-7THD/5
- For specifications, please refer to the individual items.

There are restrictions or requirements within the EU!

Please read the notes regarding wireless systems in the section "IMPORTANT INFORMATION"!

**E-7BPSET/5**

Order No. 0259612

**UHF PLL audio transmission set,**

consisting of:

- Diversity UHF PLL receiver E-7R/5
 - UHF PLL pocket transmitter with lavalier microphone E-7TB/5
- For specifications, please refer to individual items.

There are restrictions or requirements within the EU!

Please read the notes regarding wireless systems in the section "IMPORTANT INFORMATION"!

**E-7BPSETD/5**

Order No. 0259611

**UHF PLL audio transmission set,**

consisting of:

- 2-channel diversity UHF PLL receiver E-7DU/5
 - UHF PLL pocket transmitter with lavalier microphone (set of 2) E-7TBD/5
- For specifications, please refer to individual items.

There are restrictions or requirements within the EU!

Please read the notes regarding wireless systems in the section "IMPORTANT INFORMATION"!



US-8002D/1

Order No. 0254490

Diversity UHF PLL receiver

- 2 x 16 channels
- Parallel operation of up to 4 intermodulation-free frequencies
- Pilot tone squelch and fixed noise squelch
- LEDs for indicating diversity status and AF level
- 482 mm (19") unit holder DR-900SET for 1 RS rack installation of 2 x US-8002D/1 is available at option

Licence-free in the EU.

Model	US-8002D/1
Description	receiver unit
Carrier frequency range	863-865 MHz
Audio frequency range	40-18,000 Hz
THD	< 0.6%
Dynamic range	> 105 dB
Audio signal receiver	40 mV XLR, 150 mV jack
Power supply receiver	via encl. power supply
Dimensions receiver	210 x 40 x 170 mm
Weight receiver	500 g
Connections receiver	2 x XLR, bal., 1 x 6.3 mm jack, unbal.



US-8001D/1

Order No. 0254480

Diversity UHF PLL receiver

- 16 channels
- Parallel operation of up to 4 intermodulation-free frequencies
- Pilot tone squelch and fixed noise squelch
- LEDs for indicating diversity status and AF level
- 482 mm (19") unit holder DR-900SET for 1 RS rack installation of 2 x US-8001D/1 is available at option

Licence-free in the EU.

Model	US-8001D/1
Description	receiver unit
Carrier frequency range	863-865 MHz
Audio frequency range	40-18,000 Hz
THD	< 0.6%
Dynamic range	> 105 dB
Audio signal receiver	40 mV XLR, 150 mV jack
Power supply receiver	via encl. power supply
Dimensions receiver	210 x 40 x 170 mm
Weight receiver	455 g
Connections receiver	1 x XLR, bal., 1 x 6.3 mm jack, unbal.



MH-850/1

Order No. 0254460

Dynamic hand-held UHF PLL microphone transmitter

- 16 channels
- Pilot tone technology
- Special design to reduce handling noise, structure-borne noise and acoustic feedback
- Integrated low battery alert

Licence-free in the EU.

Model	MH-850/1
Polar pattern	hypercardioid
System	dynamic
Carrier frequency range	863-865 MHz
Transmitting power	10 mW
Power supply	2 x batt. AA size, alkaline (not supplied)
Operating time	25 h max.
Audio frequency range	50-16,000 Hz
Dimensions	Ø 55 mm x 260 mm
Weight	250 g



PT-850B/1

Order No. 0254470

UHF PLL pocket transmitter with lavalier microphone

- Suitable for instrument microphones of the CX series as well as headband microphones of the CX/CM series
- Supplied with lavalier microphone CM-501
- 16 preset channels
- Continuously adjustable gain
- Dual LED for indicating battery status
- Supplied with belt bag

Licence-free in the EU.

Model	PT-850B/1
Description	pocket transmitter
Carrier frequency range	863-865 MHz
Audio frequency range	40-18,000 Hz
Operating time	25 h max.
Transmitting power	10 mW
Power supply transmitter	2 x batt. AA size, alkaline (not supplied)
Dimensions transmitter	70 x 190 x 30 mm
Weight transmitter	120 g
Connections transmitter	4-pole mini XLR

**US-8001DBGY/5**

Order No. 0259846

UHF PLL audio transmission set

Consisting of:

- Diversity UHF PLL receiver US-8001DB/5
- Headband microphone with integrated 16-channel PLL transmitter UT-16HW5

For specifications, please refer to individual items.

There are restrictions or requirements within the EU!**Please read the notes regarding wireless systems in the section "IMPORTANT INFORMATION"!**

Model	US-8001DBGY/5
Description	UHF PLL audio transmission set
Carrier frequency range	518-542 MHz
Audio frequency range	40-18,000 Hz
THD	< 0.6%
Dynamic range	> 105 dB
Power supply transmitter	1 x 1.5 V AAA size (not supplied)
Weight transmitter	50 g
Audio signal receiver	40 mV XLR, 150 mV jack
Power supply receiver	via encl. power supply
Dimensions receiver	210 x 40 x 181 mm
Weight receiver	565 g
Connections receiver	1 x XLR, bal., 1 x 6.3 mm jack, unbal.

**US-8001DB/5**

Order No. 0259845

Diversity UHF PLL receiver

- 16 channels
- Parallel operation of up to 4 intermodulation-free frequencies
- Removable antennas (BNC connection)
- Pilot tone squelch and noise mute
- LED indication for diversity status and AF level
- 482 mm (19") mounting frame DR-900SET for 1 RS rack installation of 2 x US-8001DB/5 is available at option

There are restrictions or requirements within the EU!**Please read the notes regarding wireless systems in the section "IMPORTANT INFORMATION"!**

Model	US-8001DB/5
Description	receiver unit
Carrier frequency range	518-542 MHz
Audio frequency range	40-18,000 Hz
THD	< 0.6%
Dynamic range	> 105 dB
Audio signal receiver	40 mV XLR, 150 mV jack
Power supply receiver	via encl. power supply
Dimensions receiver	210 x 40 x 181 mm
Weight receiver	565 g
Connections receiver	1 x XLR, bal., 1 x 6.3 mm jack, unbal.





Accessories for Wireless Systems

05

UDA-49A

Order No. 0150630

Active UHF directional antenna

- Improved reception and a larger transmission range of 470-960 MHz
- Rejects unwanted RF signals, minimises signal loss in multipath receptions and reduces interference susceptibility
- Reliable operation also for short-term outdoor use
- Switchable gain (3 dB/10 dB) to avoid power loss
- Power supply via UHF PLL receivers of the US/IN series or the active antenna splitter UA-960
- Ideally suited for mobile applications, can be mounted onto any microphone stand with a thread of 9 mm (3/8") or 16 mm (5/8")

2 x UDA-49A required for diversity reception.

Model	UDA-49A
Frequency range	470-960 MHz
Aperture angle	100°
Antenna gain	≥ 10 dB
Power supply	= 12 V/50 mA, remote power supply (external power supply)
Impedance level	50 Ω
Support	9 mm (3/8") or 16 mm (5/8")
Dimensions	360 x 350 x 36 mm (sheet thickness: 1.7 mm)
Weight	350 g
Connection	BNC jack



UDA-49P

Order No. 0150640

Passive UHF directional antenna

- For wireless microphone systems (reception antenna) or for wireless in-ear monitoring systems, e.g. SIEM-111/5 from JTS (transmitting antenna)
- Improved reception and a larger transmission range of 470-960 MHz
- Rejects unwanted RF signals, minimises signal loss in multipath receptions and reduces interference susceptibility
- Reliable operation also for short-term outdoor use
- BNC connection (for UHF PLL receivers of the US/IN series or active antenna splitter UA-960)

Model	UDA-49P
Frequency range	470-960 MHz
Aperture angle	100°
Antenna gain	≥ 10 dB
Impedance level	50 Ω
Support	9 mm (3/8") or 16 mm (5/8")
Dimensions	360 x 350 x 36 mm (sheet thickness: 1.7 mm)
Weight	350
Connection	BNC jack



- Ideally suited for mobile applications, can be mounted onto any microphone stand with a thread of 9 mm (3/8") or 16 mm (5/8")

2 x UDA-49P required for diversity reception.

ANT-49

Order No. 0150810

Passive UHF wideband omnidirectional antenna

- For wireless microphone systems or wireless in-ear monitoring systems
- Consistent RF power supply, independent of direction
- Ideally suited for mobile applications, can be mounted onto microphone stand with 9 mm (3/8") or 16 mm (5/8") thread

2 x ANT-49 required for diversity reception.

Model	ANT-49
Frequency range	470-960 MHz
Aperture angle	360°
Antenna gain	2-4 dB
Impedance level	50 Ω
Support	9 mm (3/8") or 16 mm (5/8")
Dimensions	130 x 255 x 32 mm (sheet thickness: 2 mm)
Weight	205 g
Connection	BNC jack



USP-900

Order No. 0150650

Passive UHF antenna splitter/UHF combiner

- For minimising the great effort and expense of antennas for wireless receiver systems or transmission systems
- Splits one antenna input signal to two antenna output signals
- 2 x USP-900 required for commonly supplying two diversity receivers set up with two antennas respectively

Model	USP-900
Frequency range	10-1,000 MHz
Launch attenuation	2 dB
Decoupling	20 dB
Impedance level	50 Ω
Connection	3 x BNC jack
Dimensions	72 x 24 x 56 mm
Weight	63 g

- DC suppression
- Can also be used as a combiner in order to operate 2 x SIEM-111/5 with one antenna



UA-960

Order No. 0150820



Active antenna splitter

- For operating up to four UHF PLL receivers of the UF/US/IN series with one pair of antennas
- With this device, it is not longer required to use the respective antennas and plug-in power supplies of the individual devices
- Frequency range: 470-960 MHz
- Power supply via four low-voltage outputs (4 x = 12 V/1 A max.)

- Each antenna to be connected via BNC jacks
- Additional connection for cascading further antenna splitters
- Supplied with suitable connection cables
- Power supply for optional antenna booster UB-900I directly via UA-960 (can be deactivated internally)



UC-900

Order No. 0150580



4-way antenna combiner

- Range of applications:
 - Signals of up to four in-ear monitoring transmitters, e.g. SIEM-111/..., can be sent via one antenna
 - Signals of up to four antennas which are positioned at a certain distance from each other can be combined for extending the reception area of a stationary receiver
- Frequency range: 470-960 MHz

- Gain: 0 dB, ± 2 dB
- Maximum RF power for each input: +20 dBm (100 mW)
- Low-voltage outputs: 4 x = 12 V, 1 A max. for supplying operating voltage directly to connected transmitter
- Each antenna to be connected via BNC jacks
- Supplied with suitable connection cables



USP-124

Order No. 0150860

4-way antenna splitter

- For operating up to four antennas with one transmitter (e.g. SIEM-111/5)
- Frequency range: 470-960 MHz
- Gain: 0 dB, ± 2 dB
- All connections via BNC jacks



UB-900I

Order No. 0150830

Antenna booster, for UHF PLL receivers.

- Power supply via UHF PLL receivers of the UF/US series and IN series or via active antenna splitter UA-960
- DC feed-through output for cascading up to 2 x UB-900I max.
- Ideally suited for mobile applications, can be mounted onto microphone stand with 16 mm ($\frac{5}{8}$ ") thread



Diversity operation: one booster is required for each antenna connected!

RP-900

Order No. 0230540

Mounting plate, for offset antenna mounting.

- Black lacquered metal version
- Dimensions: 227 x 44 x 1.6 mm, 1 RS



DR-900SET

Order No. 0244770

482 mm (19", 1 RS) device holder

- For installing up to two half-rack sized receivers into one 482 mm (19") rack
- Partly profiled sheet steel for on-the-road applications and secure support

- The supplied 241 mm (9.5") rack panel with screws can cover the unrequired mounting space



RTF-20

Order No. 0252060

Coaxial antenna cable, with mounting plate.

- 2 x 20 m RG-58U coaxial cable with 2 x BNC plug each, e.g. for connecting offset antennas to respective UHF PLL receivers of the UF/US/IN series or in-ear monitoring transmitter SIEM-111/R
- Mounting plate (1 RS) with punched holes for two supplied BNC bushings

Model	RTF-20
Intended use	coaxial antenna cable
Connectors	2 x BNC plug
Length	20 m
Colour	black
Cable diameter	5 mm
Shielding value	20 dB @ 100 MHz
Impedance	50 Ω
Attenuation	7 dB
Special feature	1 RS mounting plate: 227 x 44 x 1.6 mm
Other features	frequency range: 10-1,000 MHz



RTF-2U

Order No. 0230530



Mounting bracket set, for offset antenna mounting.

- For 482 mm (19") rack installation
- Consisting of:
 - 2 x mounting bracket
 - 2 x BNC jack
 - 2 x 40 cm antenna cable with BNC plug

Model	RTF-2U
Size	for 482 mm (19")
Colour	black
Weight	105 g (pair)



RTF-1

Order No. 0230550

Coaxial antenna cable, with mounting plate.

- 2 x 0.6 m RG-58U coaxial cable with 2 x BNC plug each, e.g. for connecting offset antennas to respective UHF PLL receivers of the UF/US/IN series or in-ear monitoring transmitter SIEM-111/R
- Mounting plate (1 RS) with punched holes for two supplied BNC bushings



RTF-3

Order No. 0230560



BNC antenna cable

- 50 Ω
- 2 x BNC plug
- Length: 2 x 3 m
- 2 x BNC bushing



RM-901

Order No. 0254940



482 mm (19") mounting brackets

- For mounting CS-4, CS-8, SIEM-111/... (transmitter), TG-10STX/1, UF-10R/12, UF-20S/5 or US-9001D/... into a rack cabinet
- Metal version

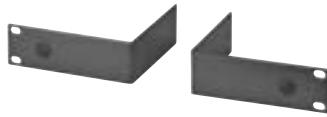

RM-10SET

Order No. 0254950

482 mm (19") mounting set

- For mounting two SIEM-111/... (transmitter), UF-10R/12 or UF-20S/5 into a rack cabinet
- Consisting of two metal mounting brackets and two aluminium connecting rails

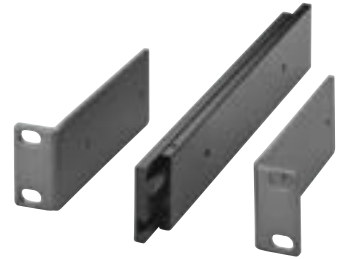

BAG-ARM/L

Order No. 0236470

Arm bag

- Suitable for wireless pocket transmitters of the PT series and in-ear monitoring receivers SIEM-111/R..., SIEM-2/R...
- Ideally suited for mobile applications
- Flexible, adjustable strap
- Removable bag with hook and loop fastener



BAG-BELT/L

Order No. 0236490

Belt bag

- Suitable for wireless pocket transmitters of the PT series and in-ear monitoring receivers SIEM-111/R..., SIEM-2/R...
- Ideally suited for mobile applications
- Flexible, adjustable strap
- Removable bag with hook and loop fastener





In-ear Monitoring Systems

06

SIEM-111/5

Order No. 0255510

MPX stereo UHF PLL in-ear monitoring system

- Wireless monitor system with excellent sound characteristics
- Individual monitor mix in stereo mode or mono/mix mode
- For live acts, e.g. theatre performances, musical performances
- 64 preset channels in 4 groups of 16 channels each
- 961 frequencies
- Up to 14 wireless monitor ways can be used for an intermodulation-free parallel operation
- Pilot tone technology and noise squelch
- Transmitter and receiver with lock function, multi-functional display and limiter
- Earphones or headphones can be connected to the transmitter via 3.5 mm or 6.3 mm stereo jack
- Supplied with high-quality in-ear earphones IE-1
- 482 mm (19") rack installation with supplied mounting brackets

Model	SIEM-111/5
Description	in-ear monitoring system
Carrier frequency range	518-542 MHz
Audio frequency range	50-15,000 Hz
Total weight	2.33 kg
Transmitting power	10 mW
Power supply transmitter	~ 100-240 V via integrated switch-mode power supply
Dimensions transmitter	212 x 44 x 239 mm
Weight transmitter	1.3 kg
Connections transmitter	2 x combo input, 2 x loop output, bal. via 6.3 mm jack
Power supply receiver	2 x batt. AA size, alkaline (not supplied)
Dimensions receiver	74 x 196 x 34 mm
Weight receiver	300 g
Connections receiver	3.5 mm stereo jack



There are restrictions or requirements within the EU!

Please read the notes regarding wireless systems in the section "IMPORTANT INFORMATION"!

SIEM-111/R5

Order No. 0255520

UHF PLL in-ear monitoring receiver, as an addition to in-ear monitoring system SIEM-111/5.

- Excellent audio characteristics
- Pilot tone technology
- Peak limiter, can be activated as required
- Individual monitor mix in stereo mode or mono/mix mode
- Ear-selective level matching possible via balance adjustment
- Operating controls with lock function
- Clearly arranged multifunctional display

There are restrictions or requirements within the EU!

Please read the notes regarding wireless systems in the section "IMPORTANT INFORMATION"!

Model	SIEM-111/R5
Description	in-ear monitoring receiver
Carrier frequency range	518-542 MHz
Audio frequency range	50-15,000 Hz
THD	0.8%
Dynamic range	> 80 dB
Operating time	> 8 h
Power supply receiver	2 x batt. AA size, alkaline (not supplied)
Dimensions receiver	74 x 196 x 34 mm
Weight receiver	202 g
Connections receiver	3.5 mm stereo jack



SIEM-2/5

Order No. 0255530

Mono UHF PLL in-ear monitoring system

- 16 preset channels
- Integrated limiter
- Loop outputs on the rear panel
- Switchable transmitting power
- Supplied with high-quality in-ear earphones IE-1
- 482 mm (19") unit holder DR-900SET for 1 RS rack installation of 2 x SIEM-2/5 transmitter max. is available at option

There are restrictions or requirements within the EU!

Please read the notes regarding wireless systems in the section "IMPORTANT INFORMATION"!

Model	SIEM-2/5
Description	in-ear monitoring system
Carrier frequency range	518-542 MHz
Audio frequency range	40-18,000 Hz
Operating time	> 8 h
Transmitting power	10/50 mW
Power supply transmitter	~ 100-240 V via encl. plug-in power supply
Dimensions transmitter	210 x 42 x 180 mm
Weight transmitter	460 g
Connections transmitter	2 x combo (in) 2 x 6.3 mm jack, bal. (loop out)
Power supply receiver	2 x batt. AA size, alkaline (not supplied)
Dimensions receiver	75 x 160 x 32 mm
Weight receiver	90 g
Connections receiver	6.3 mm stereo jack



SIEM-2/R5

Order No. 0255540

Mono UHF PLL in-ear monitoring receiver, as an addition to in-ear monitoring system SIEM-2/5.

- Switchable limiter
- Separate adjustable mic/line input
- Phantom power supply: 4 V
- Low battery alert
- Belt clip
- Impact-proof plastic housing for severe conditions on stage

There are restrictions or requirements within the EU!

Please read the notes regarding wireless systems in the section "IMPORTANT INFORMATION"!

Model	SIEM-2/R5
Description	in-ear monitoring receiver
Carrier frequency range	518-542 MHz
Audio frequency range	40-18,000 Hz
Dynamic range	> 80 dB
Operating time	> 8 h
Power supply receiver	2 x batt. AA size, alkaline (not supplied)
Dimensions receiver	75 x 160 x 32 mm
Weight receiver	83 g
Connections receiver	6.3 mm stereo jack



IE-1

Order No. 0220810

Stereo in-ear earphones

- Especially designed for application with in-ear systems SIEM
- Musical experience rich in detail due to a brilliant reproduction of the high frequencies, a natural midrange and a reproduction of the entire bass range
- Three pairs of silicone sleeves in different sizes ensure an excellent isolation of the background noise and a perfect fit, very comfortable to wear without pressure even after hours of wearing

Model	IE-1
Type of transducer	dynamic
Max. input power	100 mW
Transmission range, headphones	20-20,000 Hz
Nominal impedance, headphones	16 Ω
Headphone sensitivity	114 dB/mW
Cable	1.5 m
Plug	3.5 mm stereo plug
Weight w/o cable	6 g



IE-5

Order No. 0221240

Stereo in-ear earphones

- Wideband in-ear earphone in BA technology (Balanced Armature) with a transparent sound rich in detail
- The supplied pairs of silicone sleeves in different sizes ensure a perfect fit in the ear canal and an excellent isolation of the background noise, thus providing a defined bass reproduction
- Formable and individually adjustable ear hook
- The fabric-reinforced anti-twist cable can easily be replaced (replacement cable: IE-5C)

Model	IE-5
Type of transducer	balanced armature
Max. input power	100 mW
Transmission range, headphones	20-13,000 Hz
Nominal impedance, headphones	13 Ω
Headphone sensitivity	115 dB/mW
Cable	1.4 m
Plug	3.5 mm stereo plug
Weight w/o cable	5 g





Headband Microphones and Lavalier Microphones

07

HSE-300/SK

Order No. 0234080

Professional headband microphone

- Cardioid polar pattern
- Maximum suppression of impact sound and structure-borne noise
- Extra low acoustic feedback
- Corrosion-resistant neckband, easy to clean
- Unobtrusive and secure fit due to cable routing in neck area incl. strain relief and cable bending protection
- Drip ring (protects cartridge from moisture)
- Microphone windshield

Model	HSE-300/SK
Polar pattern	cardioid
System	electret
Audio frequency range	50-18,000 Hz
Nominal impedance	2 k Ω
Sensitivity	2.3 mV/Pa
Max. sound pressure	120 dB
Power supply	= 1.5-9 V
Weight	18 g (w/o cable and plug)
Connection	bare cable ends

- External power supply, e.g. via phantom power supply adapter EMA-1 or EMA-300P
- Bare cable ends



CM-235IF

Order No. 0235970

CM-235IB

Order No. 0235960

Electret headband microphones

- High-quality microphone cartridge with omnidirectional polar pattern
- Very comfortable to wear
- Adjustable headband
- Replaceable connection cable
- Suitable for kids
- Highly flexible gooseneck boom
- Drip ring (protects cartridge from moisture)
- 4-pole mini XLR inline jack for connection to a pocket transmitter of the IN/PT/UF series, other connection cables are available at option

Model	CM-235IF, CM-235IB
Polar pattern	omnidir.
System	electret
Audio frequency range	50-18,000 Hz
Nominal impedance	1.8 k Ω
Sensitivity	2.2 mV/Pa
Max. sound pressure	130 dB
Power supply	pocket transmitter IN/PT/UF series or PS-500
Weight	17 g
Connection	4-pole mini XLR (optional: 3.5 mm stereo plug, 3-pole mini XLR or 4-pole Hirose connector)

- Beige (CM-235IF) or black (CM-235IB) version
- Supplied with bag and windshield

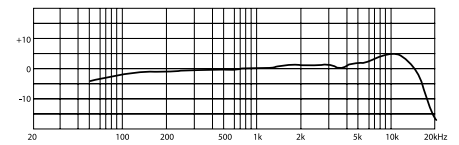
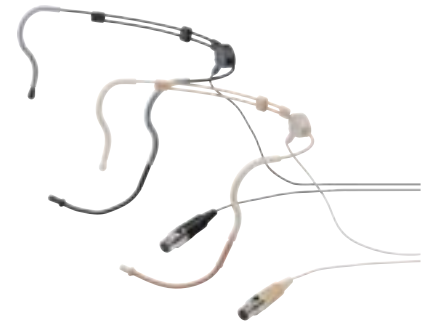

CM-214F

Order No. 0236430

Electret headband microphone

- Omnidirectional polar pattern allows for microphone to be positioned slightly next to the mouth in an unobtrusive way instead of directly in front of the mouth
- Ultra-light and adjustable headband
- Replaceable connection cable
- Secure fit, very comfortable to wear
- Drip ring protects cartridge from moisture and ensures a long operating life
- For connection to the pocket transmitters of the IN/PT/UF series with 4-pole mini XLR connection cable

Model	CM-214F
Polar pattern	omnidir.
System	electret
Audio frequency range	60-15,000 Hz
Nominal impedance	2.2 k Ω
Sensitivity	10 mV/Pa
Max. sound pressure	130 dB
Power supply	pocket transmitter IN/PT/UF series or PS-500
Weight	40 g
Connection	cable with 4-pole mini XLR (optional 3.5 mm stereo plug, 3-pole mini XLR or 4-pole Hirose connector)

- Other connection cables are available at option
- Supplied with bag and windshield

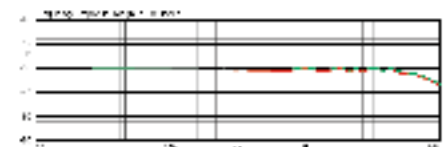
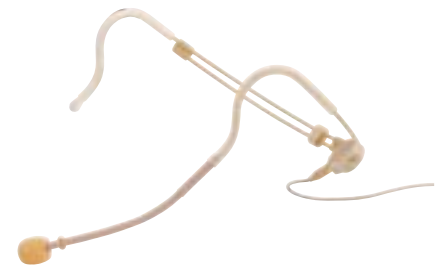

CM-214ULF

Order No. 0236450

Electret headband microphone

- Transparent sound
- Adjustable headband, comfortable to wear
- Highly resistant to acoustic feedback due to cardioid polar pattern
- Replaceable connection cable
- Flexible cartridge arm for exact positioning of cartridge, thus providing an optimum sound with an unobtrusive appearance
- Connection cable with strain relief, screwed-on
- Integrated drip ring protects the cartridge from moisture
- Supplied with a 4-pole mini XLR connection cable

Model	CM-214ULF
Polar pattern	cardioid
System	electret
Audio frequency range	100-18,000 Hz
Nominal impedance	1.5 k Ω
Sensitivity	1.8 mV/Pa
Max. sound pressure	120 dB
Power supply	pocket transmitter IN/PT/UF series or PS-500
Weight	44 g
Connection	4-pole mini XLR (optional: 3.5 mm stereo plug, 3-pole mini XLR or 4-pole Hirose connector)

for connection to pocket transmitters of the IN/PT/UF series

- Other connection cables are available at option
- Supplied with bag and windshield

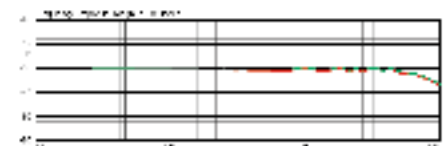

Headband Microphones and Lavalier Microphones

CM-801F

Order No. 0235900

Electret earband microphone

- Ultra-light earband microphone for stage and podium
- Optimum speech intelligibility
- Movable drip ring
- Screwed-on cable, easy to replace
- Clip for strain relief; makes microphone more comfortable to wear and enhances stable positioning
- Other connection cables are available at option
- Supplied with bag and windshield

Model	CM-801F
Polar pattern	omnidir.
System	electret
Audio frequency range	60-15,000 Hz
Nominal impedance	1.8 k Ω
Sensitivity	6.3 mV/Pa
Max. sound pressure	130 dB
Power supply	pocket transmitters of the IN/PT/UF series or PS-500
Weight	16 g
Connection	4-pole mini XLR (optional: 3.5 mm stereo plug, 3-pole mini XLR or 4-pole Hirose connector)



CM-804IF

Order No. 0236090

Electret headband microphone

- Lightweight, very comfortable to wear, expressive sound
- Adjustable neckband, lockable
- Integrated drip ring protects cartridge from moisture
- Folding ear hook
- Connection cable with strain relief, screwed-on
- Other connection cables are available at option
- Supplied with bag, windshield and collar clip

Model	CM-804IF
Polar pattern	omnidir.
System	electret
Audio frequency range	60-15,000 Hz
Nominal impedance	1.8 k Ω
Sensitivity	6.3 mV/Pa
Max. sound pressure	130 dB
Power supply	pocket transmitter IN/PT/UF series or PS-500
Weight	20 g
Connection	4-pole mini XLR (optional: 3.5 mm stereo plug, 3-pole mini XLR or 4-pole Hirose connector)



CM-501

Order No. 0234690

Electret lavalier microphone

- For presentations and discussions
- Good audibility, secure fit due to supplied tie clip, easy to attach
- Cardioid polar pattern
- Allows to pick up a precise voice of high quality over a wide dynamic range
- Supplied with windshield

Model	CM-501
Polar pattern	cardioid
System	electret
Audio frequency range	100-15,000 Hz
Nominal impedance	2.2 k Ω
Sensitivity	3.2 mV/Pa
Max. sound pressure	130 dB
Power supply	pocket transmitter IN/PT/UF series or PS-500
Weight	20 g
Connection	4-pole mini XLR



NM-43

Order No. 0235070

Neckband

- Matching the lavalier microphone CM-501
- Adjustable
- Lightweight plastic version

Supplied w/o microphone.



PT-RMS

Order No. 0236870

External mute button (cough button)

- For tie clip microphones and headband microphones from JTS
- Selectable switching mode (ON/OFF, momentary ON, momentary OFF)
- 4-pole mini XLR connection
- Compatible with any pocket transmitter from JTS



CM-125IB

Order No. 0235940

CM-125IF

Order No. 0235950

Electret lavalier microphones, miniature version.

- High-quality microphone cartridge with omnidirectional polar pattern
- Excellent sound characteristics
- Removable clip and 1.4 m connection cable
- 4-pole mini XLR inline jack for connection to a pocket transmitter of the IN/PT/UF series
- Beige (CM-125IF) or black (CM-125IB) version
- Supplied with bag and windshield

Model	CM-125IB	CM-125IF
Polar pattern	omnidir.	omnidir.
System	electret	electret
Audio frequency range	50-18,000 Hz	50-18,000 Hz
Nominal impedance	4.4 k Ω	4.4 k Ω
Sensitivity	2.2 mV/Pa	22 mV/Pa
Max. sound pressure	130 dB	130 dB
Power supply	pocket transmitter of the IN/PT/UF series or PS-500	pocket transmitter of the IN/PT/UF series or PS-500
Weight	15 g	15 g
Connection	4-pole mini XLR	4-pole mini XLR



801CR

Order No. 0236530

801CR/B

Order No. 0237250

Connection cable

- Beige (801CR) or black (801CR/B) version
- 4-pole Hirose connector
- Length: 150 cm
- Suitable for CM-801F, CM-804IF, CM-214F, CM-214ULF and CM-235IF, CM-235IB



801CS

Order No. 0236110

801CS/B

Order No. 0237260

Connection cable

- Beige (801CS) or black (801CS/B) version
- Screwable 3.5 mm plug
- Length: 150 cm
- Suitable for CM-801F, CM-804IF, CM-214F, CM-214ULF and CM-235IF



801C3

Order No. 0236120

801C3/B

Order No. 0237240

Connection cable

- Beige (801C3) or black (801C3/B) version
- 3-pole mini XLR connector
- Length: 150 cm
- Suitable for CM-801F, CM-804IF, CM-214F, CM-214ULF and CM-235IF, CM-235IB



801C4

Order No. 0069240

801C4/B

Order No. 0069410

Connection cable

- Beige (801C4) or black (801C4/B) version
- 4-pole mini XLR connector
- Length: 150 cm
- Suitable for CM-801F, CM-804IF, CM-214F, CM-214ULF and CM-235IF, CM-235IB





Instrument Microphones, Vocal Microphones, Studio Microphones and Headphones

08

CX-500F

Order No. 0236190

Miniature electret instrument microphone, for sound pickup of flutes.

- Gold-plated back electret cartridge with omnidirectional polar pattern
- Very precise frequency response
- Innovative, glueless fastening system (for tube diameter: 18-26 mm)
- Flexible miniature gooseneck for exact positioning of the microphone
- 4-pole mini XLR inline jack for connection to a pocket transmitter of the IN/PT/UF series, other connection cables are available at option

Model	CX-500F
Polar pattern	omnidir.
System	back electret
Audio frequency range	20-20,000 Hz
Nominal impedance	1.5 k Ω
Sensitivity	12.6 mV/Pa
Max. sound pressure	130 dB
Power supply	= 48 V, phantom power via power supply adapter
Housing material	plastic
Weight	8 g
Cable	1.4 m
Connection	4-pole mini XLR adapter: XLR, bal.

- Supplied with phantom power supply adapter MA-500 for wired connection to a mixer
- Supplied with robust transport case, phantom power supply adapter and windshield

**CX-500DUSET**

Order No. 0236710

Miniature electret instrument microphone

- For acoustic guitars, string instruments and other acoustic instruments
- Combined with the integrated contact microphone, it creates a genuine sound which is rich in detail and perfectly delivers the natural sound characteristics of the instrument across a wide dynamic range
- Individual volume control of instrument microphone and contact microphone possible via supplied phantom power supply adapter/mixer

Model	CX-500DUSET
Polar pattern	omnidir.
System	back electret
Audio frequency range	20-20,000 Hz
Nominal impedance	1.5 k Ω
Sensitivity	12.6 mV/Pa
S/N ratio	68 dB
Max. sound pressure	130 dB
Power supply	= 1-5 V via PS-510M
Weight	6.5 g
Connection	2 x 4-pole mini XLR

- Supplied with 2 windshields, 2 self-adhesive pads
- Supplied in a robust plastic case

**CX-500**

Order No. 0235850

Miniature electret instrument microphone

- For strings and other acoustic instrumentalists
- Pure and powerful sound which perfectly reproduces the natural sound characteristics of the instrument across a wide dynamic range
- Versatile options for attaching the microphone and precisely position it to achieve a perfect alignment and protect the instrument from damage
- 10 dB attenuator and 2 switchable low cut filters in the phantom power supply adapter
- Power supply adapter with belt clip
- Wireless operation possible with respective wireless systems from JTS

Model	CX-500
Polar pattern	omnidir.
System	electret
Nominal impedance	1.5 k Ω
Sensitivity	6.3 mV/Pa
Max. sound pressure	130 dB
Power supply	= 48 V, phantom power via MA-500
Housing material	plastic
Weight	15 g
Connection	4-pole mini XLR adapter: XLR, bal.

- Supplied with 48 V phantom power supply adapter, 2 tailpieces, 5 body clips, 4 windshields, 26 self-adhesive pads
- Supplied in a robust plastic case

**CX-500FHW**

Order No. 0235980

Electret headband microphone, for sound pickup of flutes.

- High-quality microphone cartridge with omnidirectional polar pattern
- Very comfortable to wear
- Adjustable headband
- Microphone boom adjustable in length
- Suitable for kids
- Drip ring (protects cartridge from moisture)
- 4-pole mini XLR inline jack for connection to pocket transmitter of the IN/PT/UF series, other connection cables are available at option

Model	CX-500FHW
Polar pattern	omnidir.
System	electret
Audio frequency range	20-20,000 Hz
Nominal impedance	1.5 k Ω
Sensitivity	12.5 mV/Pa
Max. sound pressure	130 dB
Power supply	pocket transmitter IN/PT/UF series or = 12-48 V, phantom power via MA-500
Weight	6.5 g
Connection	4-pole mini XLR

- Supplied with phantom power supply adapter MA-500 for wired connection to a mixer
- Supplied with bag, clip and windshield



Instrument Microphones

CX-520

Order No. 0236200

Dynamic instrument microphone

- For blues harp harmonica players and traditional harmonica players
- Vocalists of techno or dance music like to use it for adding a special effect to their performance
- Dynamic supercardioid cartridge for a constant quality over a wide dynamic range
- Robust diecast body of an ergonomic design
- Volume control directly at the microphone
- Wireless operation directly via any pocket transmitter from JTS
- Wired operation possible via supplied adapter MA-500 (with additional features, e.g. switchable low cut filter and PAD) and optional XLR cable
- Supplied with robust transport case and cable adapter

Model	CX-520
Polar pattern	supercardioid
System	dynamic
Audio frequency range	15-16,500 Hz
Nominal impedance	600 Ω
Sensitivity	1.3 mV/Pa
Max. sound pressure	148 dB
Weight	350 g
Cable	1.4 m
Connection	4-pole mini XLR adapter: XLR, bal.



CX-516

Order No. 0234640

CX-516W

Order No. 0234630

Electret instrument microphones

- For sound pickup of accordions, pianos or wind instruments
- Well-balanced frequency response for a genuine and brilliant sound
- Structure-borne noise isolated cartridge
- Flexible gooseneck
- Quick-acting holder of special design
- Supplied in a robust transport case with windshield

Model	CX-516	CX-516W
Polar pattern	supercardioid	supercardioid
System	electret	electret
Audio frequency range	20-20,000 Hz	20-20,000 Hz
Nominal impedance	220 Ω ± 30%	220 Ω ± 30%
Sensitivity	5.6 mV/Pa	4.5 mV/Pa
Max. sound pressure	130 dB	130 dB
Power supply	48 V phantom power	pocket transmitter from JTS
Housing material	plastic	plastic
Weight	63 g	55 g
Cable	3.3 m	1.4 m
Connection	3-pole XLR	4-pole mini XLR



CX-508

Order No. 0234610

CX-508W

Order No. 0234620

Electret instrument microphones

- For sound pickup of wind instruments
- Wide dynamic range
- Crystal-clear and crisp sound
- Integrated spring-type clamp to attach to a horn
- Robust gooseneck, can be turned by 230°
- Design of low structure-borne noise with low susceptibility to wind noise
- Supplied in a robust transport case and windshield

Model	CX-508	CX-508W
Polar pattern	cardioid	cardioid
System	electret	electret
Audio frequency range	50-18,000 Hz	50-18,000 Hz
Nominal impedance	220 Ω	220 Ω
Sensitivity	5 mV/Pa	4.5 mV/Pa
Max. sound pressure	130 dB	130 dB
Power supply	48 V phantom power	pocket transmitter from JTS
Housing material	plastic	plastic
Weight	170 g	170 g
Cable	3.3 m	1.4 m
Connection	3-pole XLR	4-pole mini XLR



CX-505

Order No. 0234590

Electret instrument microphone

- State-of-the-art microphone for drummers and percussionists
- Brilliant sound which is always accentuated and powerful, even at great dynamic gaps
- Clamp with rubber jaws, to be attached to the rim of drums
- Miniature gooseneck, can be turned by 230°
- Suppression of structure-borne noise
- Supplied in a robust transport case

Model	CX-505
Polar pattern	cardioid
System	electret
Audio frequency range	50-18,000 Hz
Nominal impedance	220 Ω
Sensitivity	5.6 mV/Pa
Max. sound pressure	130 dB
Power supply	= 48 V, phantom power
Housing material	plastic
Weight	187 g
Connection	XLR, bal.



NX-9

Order No. 0234750

Overhead electret microphone

- For various applications: sound pickup of hi-hats/ cymbals/percussion instruments, microphone applications with acoustic instruments, e.g. guitars, violins, pianos or wind instruments
- Well-balanced and natural sound
- Operation via +48 V phantom power or via 1.5 V battery AA size (not supplied)
- Supplied with microphone holder and padded bag

Model	NX-9
Polar pattern	cardioid
System	electret
Audio frequency range	60-18,000 Hz
Nominal impedance	400 Ω \pm 30%
Sensitivity	3.2 mV/Pa
Max. sound pressure	145 dB
Power supply	\approx 48 V phantom power or 1 x batt. AA size (not supplied)
Housing material	diecast metal
Weight	230 g
Connection	XLR, bal.

**NX-2**

Order No. 0234820

Dynamic instrument microphone

- For sound pickup of bass drums, kick drums, bass amplifiers or various other bass instruments
- Suppression of structure-borne noise/impact noise
- Excellent mechanical features
- Integrated stand holder
- Supplied with padded bag

Model	NX-2
Polar pattern	supercardioid
System	dynamic
Audio frequency range	20-12,000 Hz
Nominal impedance	600 Ω
Sensitivity	0.6 mV/Pa
Max. sound pressure	172 dB
Housing material	diecast metal
Weight	800 g
Connection	XLR, bal.

**NX-6**

Order No. 0234810

Dynamic instrument microphone

- For sound pickup of drums or percussion instruments, e.g. snare drums, tom-toms, congas or bongos
- Also suitable for use as a microphone with wind instruments, at a guitar amplifier or for sound pickup of acoustic instruments
- Transparent and very powerful sound
- Suppression of structure-borne noise
- High-quality workmanship of the mechanical features
- Integrated stand holder with continuously variable adjustment
- Supplied with padded bag

Model	NX-6
Polar pattern	cardioid
System	dynamic
Audio frequency range	60-16,000 Hz
Nominal impedance	600 Ω
Sensitivity	2.5 mV/Pa
Max. sound pressure	158 dB
Housing material	diecast metal
Weight	610 g
Connection	XLR, bal.



JS-1E

Order No. 0232490

Large diaphragm condenser microphone, for studio applications.

- Extra thin gold-plated 2.5 cm (1") diaphragm
- 48 V phantom power
- Scope of delivery includes microphone holder with 16 mm (5/8") thread and microphone windshield
- Supplied in a foam-padded case

Model	JS-1E
Polar pattern	cardioid
System	condenser
Audio frequency range	20-20,000 Hz
Nominal impedance	200 Ω
Sensitivity	12.6 mV/Pa
S/N ratio	78 dB
Max. sound pressure	132 dB
Power supply	= 48 V phantom power
Dimensions	Ø 56 mm x 184 mm
Weight	480 g
Connection	XLR, bal.

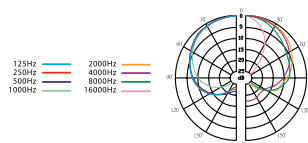
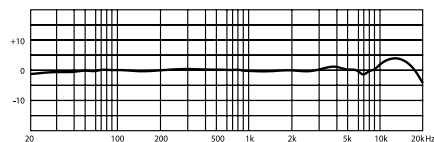

NX-8.8

Order No. 0234760

Electret vocal microphone

- Excellent vocal sound which allows studio quality at live performances
- High-quality electret condenser cartridge for a warm and natural sound with a high resistance to acoustic feedback
- Filter technology minimises breathing noise and pop noise
- Robust diecast body and stable basket
- Supplied with microphone holder and padded bag

Model	NX-8.8
Polar pattern	supercardioid
System	electret
Audio frequency range	60-18,000 Hz
Nominal impedance	400 Ω ±30%
Sensitivity	3.2 mV/Pa
Max. sound pressure	136 dB
Power supply	= 48 V phantom power
Housing material	diecast metal
Weight	290 g
Connection	XLR, bal.



NX-8

Order No. 0234770

Dynamic vocal microphone

- Accentuated and clear voice reproduction
- Wide dynamic range
- Significantly reduced transmission of the handling noise
- Non-slip and durable due to special stove-enamel finish
- High-quality and solid workmanship
- Supplied with microphone holder and padded bag

Model	NX-8
Polar pattern	cardioid
System	dynamic
Audio frequency range	50-16,500 Hz
Nominal impedance	600 Ω
Sensitivity	2.5 mV/Pa
Max. sound pressure	138 dB
Housing material	diecast metal
Weight	245 g
Connection	XLR, bal.



NX-8S

Order No. 0234780

Dynamic vocal microphone

- Accentuated and clear voice reproduction
- Wide dynamic range
- Low-noise reed switch resistant to wear
- Significantly reduced transmission of the handling noise
- Non-slip and durable due to special stove-enamel finish
- High-quality and solid workmanship
- Supplied with microphone holder and padded bag

Model	NX-8S
Polar pattern	cardioid
System	dynamic
Audio frequency range	50-16,500 Hz
Nominal impedance	600 Ω
Sensitivity	2.5 mV/Pa
Max. sound pressure	138 dB
Housing material	diecast metal
Weight	245 g
Connection	XLR, bal.



TK-600

Order No. 0234890

Dynamic vocal microphone

- Impressive vocal microphone, also meets high requirements, available at an attractive price
- Powerful and brilliant sound reproduction
- Minimised handling noise
- Low susceptibility to acoustic feedback
- Mechanical stability
- Low-noise reed switch resistant to wear
- Supplied with connection cable

Model	TK-600
Polar pattern	cardioid
System	dynamic
Audio frequency range	50-16,000 Hz
Nominal impedance	600 Ω
Sensitivity	1.8 mV/Pa
Max. sound pressure	147 dB
Housing material	diecast metal
Weight	380 g
Cable	XLR, bal.
Connection	XLR, bal.



TK-350

Order No. 0234880

Dynamic vocal microphone

- Frequency response optimised for vocals
- Clear voice reproduction
- Powerful band sound
- Minimised handling noise and structure-borne noise, low susceptibility to acoustic feedback
- High-quality reed switch allows silent switching actions
- Supplied with connection cable

Model	TK-350
Polar pattern	cardioid
System	dynamic
Audio frequency range	80-12,000 Hz
Nominal impedance	600 Ω
Sensitivity	1.8 mV/Pa
Max. sound pressure	145 dB
Housing material	diecast metal
Weight	380 g
Cable	XLR, bal., XLR, bal.
Connection	XLR, bal.



TM-989

Order No. 0234960

TM-969

Order No. 0234950

Dynamic vocal microphone

- For ambitious vocalists
- Powerful sound
- Ball-type microphone head grille
- Supplied with connection cable

Model	TM-989	TM-969
Polar pattern	cardioid	cardioid
System	dynamic	dynamic
Audio frequency range	80-12,000 Hz	80-12,000 Hz
Nominal impedance	600 Ω	600 Ω
Sensitivity	1.8 mV/Pa	1.8 mV/Pa
Max. sound pressure	146 dB	146 dB
Housing material	diecast metal	diecast metal
Weight	245 g	245 g
Cable	XLR, bal., 6.3 mm plug, unbal.	XLR, bal., 6.3 mm plug, unbal.
Connection	XLR, bal.	XLR, bal.



TM-929

Order No. 0234940

Dynamic vocal microphone

- High-quality entry-level microphone, classic design
- Robust body
- Suppression of handling noise and acoustic feedback
- Low-noise reed switch
- Supplied with connection cable

Model	TM-929
Polar pattern	cardioid
System	dynamic
Audio frequency range	50-15,000 Hz
Nominal impedance	600 Ω
Sensitivity	1.8 mV/Pa
Max. sound pressure	148 dB
Housing material	diecast metal
Weight	350 g
Cable	XLR, bal., 6.3 mm plug, unbal.
Connection	XLR, bal.



PDM-3

Order No. 0234850

Dynamic vocal microphone

- Frequency response especially optimised for the vocal spectrum
- Low handling noise and high acoustic feedback suppression
- Robust design for a long life
- Supplied with connection cable

Model	PDM-3
Polar pattern	cardioid
System	dynamic
Audio frequency range	50-16,500 Hz
Nominal impedance	600 Ω
Sensitivity	1.8 mV/Pa
Max. sound pressure	147 dB
Housing material	diecast metal
Weight	315 g
Cable	XLR, bal., XLR, bal.
Connection	XLR, bal.



CP-40

Order No. 0235250

Replacement microphone head, suitable for PDM-3 as well as microphones of the same design.



WA-35

Order No. 0172940



Portable MP3 FM amplifier system with wireless microphone

- Compact and ultra-light class D amplifier system (total weight: 1.75 kg)
- Power capability of 25 W in battery operation (integrated 14.8 V rech. LiPo battery) and 35 W with power supply
- Ideally suited for outdoor applications due to splash-proof housing, stainless steel screws, impregnated full range speaker with dual cone and push-on silicone cover for the control unit
- MP3 reproduction via USB interface and SD card slot
- FM radio with 20 station presets
- Wireless 16-channel microphone system in the licence-free range 863-865 MHz (1 x 1.5 V battery, AA size, not supplied)
- Sound adjustment

Model	WA-35
Rated power (P _{RMS})	25 W (rech. batt.), 35 W (mains)
Peak output power	60 W
Carrier frequency	863-865 MHz
Power supply	14.8 V rech. LiPo battery, via power supply
Dimensions	146 x 179 x 223 mm
Weight	1.75 kg
Connections	1 x 6.3 mm jack (mic), 1 x USB

- Connection facility for a cable-connected microphone
- Alarm siren: 2-tone and wailing sound
- LED lamp with continuous light, automatic SOS light and automatic flashing light
- Charging status indication
- Deep discharge protection
- 9 mm (3/8") stand sleeve
- Integrated recessed carrying handle
- Robust carrying strap with integrated microphone bag

Licence-free in the EU.



HP-565

Order No. 0221300

Professional studio headphones

- Excellent sound quality and a rich bass reproduction
- Semi-open system, over-ear
- Padded ear cushions and headband, comfortable to wear
- 3 m cable with single-sided cable inlet
- 3.5 mm plug with 6.3 mm adapter

Model	HP-565
Headphone driver	neodymium, Ø 40 mm
Type of transducer	dynamic
Max. input power	500 mW
Transmission range, headphones	20-20,000 Hz
Nominal impedance, headphones	32 Ω
Headphone sensitivity	104 dB/mW
Cable	3 m, single-sided cable inlet
Plug	3.5 mm plug, gold-plated
Adapter	6.3 mm plug, gold-plated
Weight w/o cable	350 g

**HP-535**

Order No. 0220790

Professional studio monitor headphones

- Excellent sound quality, very comfortable to wear
- Semi-open system, over-ear
- Padded ear cushions and headrest
- 2 m cable with single-sided cable inlet
- 3.5 mm plug with 6.3 mm adapter

Model	HP-535
Headphone driver	neodymium, Ø 40 mm
Type of transducer	dynamic
Max. input power	1 W
Transmission range, headphones	20-20,000 Hz
Nominal impedance, headphones	64 Ω
Headphone sensitivity	104 dB/mW
Cable	2 m, single-sided cable inlet
Plug	3.5 mm plug, gold-plated
Adapter	6.3 mm plug, gold-plated
Weight w/o cable	380 g

**HPM-535**

Order No. 0220210

Professional stereo headphones with electret boom microphone

- Excellent sound characteristics, comfortable to wear
- Semi-open system, over-ear
- Compatible with sound cards
- Ideally suited for gaming
- Adjustable microphone boom
- Padded ear cushions and headband
- 2 m cable with single-sided cable inlet and 3.5 mm plugs

Model	HPM-535
Headphone driver	neodymium, Ø 40 mm
Type of transducer	dynamic
Max. input power	1,000 mW
Transmission range, headphones	20-20,000 Hz
Nominal impedance, headphones	64 Ω
Headphone sensitivity	104 dB/mW
Transmission range, mic.	100-15,000 Hz
Nominal impedance, microphone	680 Ω
Microphone system	electret
Microphone sensitivity	6.3 mV/Pa/1 kHz
Power supply	= 1.5-10 V
Cable	2 m, single-sided cable inlet
Plug	2 x 3.5 mm plug, gold-plated
Weight w/o cable	308 g





Universal Microphones, Overhead Microphones and Boundary Microphones

09

PDM-57

Order No. 0234860

Universal dynamic microphone

- For general sound pickup of instruments and for live performances
- Natural sound characteristics
- Characteristic sound with a high recognition value
- Supplied with connection cable

Model	PDM-57
Polar pattern	cardioid
System	dynamic
Audio frequency range	50-16,500 Hz
Nominal impedance	600 Ω
Sensitivity	1.8 mV/Pa
Max. sound pressure	145 dB
Housing material	diecast metal
Weight	250 g
Cable	XLR, bal., XLR, bal.
Connection	XLR, bal.



SGM-14

Order No. 0236730

Electret shotgun microphone

- For outdoor recordings, e.g. film productions and video productions
- Low-cut switch (80 Hz)
- 10 dB attenuation, switchable
- Supplied with microphone holder and windshield

Model	SGM-14
Polar pattern	hypercardioid
System	electret/condenser
Audio frequency range	20-20,000 Hz
Nominal impedance	200 Ω
Sensitivity	25 mV/Pa
Max. sound pressure	125 dB
Power supply	9-48 V phantom power
Dimensions	Ø 22 mm x 357 mm
Weight	195 g
Connection	3-pole XLR



JS-22

Order No. 0231970

Professional condenser microphone, for studio applications and live performances. Ideally suited for direct or overhead sound pickup of acoustic instruments, percussions and vocals or 2 x JS-22 for high-quality stereo recordings.

- 1.25 cm (1/2") extra thin gold-plated diaphragm
- Low cut switch (80 Hz)
- 10 dB attenuation, switchable
- 48 V phantom power
- Robust brass body of high quality

Model	JS-22
Polar pattern	cardioid
System	condenser
Audio frequency range	20-20,000 Hz
Nominal impedance	100 Ω
Sensitivity	15.8 mV/Pa
S/N ratio	78 dB
Max. sound pressure	140 dB
Power supply	= 48 V, phantom power
Housing material	brass
Dimensions	Ø 20 mm x 150 mm
Weight	130 g
Connection	XLR, bal.



- Supplied accessories: robust hard-sided case, microphone windshield and microphone holder

CX-509

Order No. 0234710

Overhead electret microphone

- For sound pickup of hi-hats/cymbals as well as various percussion instruments and acoustic instruments, e.g. guitars/violins, flutes or choir voices
- Excellent sound characteristics
- Unobtrusive positioning due to small dimensions
- Robust body with integrated phantom power supply adapter
- Supplied with microphone holder

Model	CX-509
Polar pattern	cardioid
System	electret/cardioid
Audio frequency range	20-20,000 Hz
Nominal impedance	220 Ω ± 30%
Sensitivity	5.6 mV/Pa
Max. sound pressure	130 dB
Power supply	48 V phantom power
Housing material	metal
Weight	60 g
Connection	XLR, bal.



CM-502

Order No. 0234580

CM-502WT

Order No. 0233990

Overhead hanging electret microphones

- For suspended installations, especially suitable for applications in which a direct microphonic effect is undesired for optical or operational reasons, e.g. sound pickup of choirs or on theatre stages or school stages
- Microphone cartridge with supercardioid polar pattern
- Integrated phantom power supply adapter
- Easy installation and alignment due to supplied mounting plate for ceiling suspension and spring holder
- Supplied with windshield

Model	CM-502, CM-502WT
Polar pattern	supercardioid
System	electret
Audio frequency range	100-18,000 Hz
Nominal impedance	220 Ω
Sensitivity	4 mV/Pa
Max. sound pressure	125 dB
Power supply	= 12-48 V, phantom power
Housing material	metal
Weight	190 g
Cable	7.5 m
Connection	XLR, bal.

CM-502WT: white version



Overhead Microphones

CM-502G6B

Order No. 0233950

CM-502G6W

Order No. 0233960

CM-502G12B

Order No. 0233970

CM-502G12W

Order No. 0233980

Overhead hanging electret microphone

- For suspended installations, especially suitable for applications in which a direct microphonic effect is undesired for optical or operational reasons, e.g. sound pickup of choirs or on theatre stages or school stages
- Microphone cartridge with supercardioid polar pattern
- Integrated phantom power supply adapter
- Flexible alignment due to gooseneck
- Easy-to-replace cartridge unit
- Black (CM-502G...B) or white (CM-502G...W) version
- Supplied with windshield

Total length:

CM-502G6...: 180 mm

CM-502G12...: 320 mm



CM-502G12B = black
CM-502G12W = white

CM-502G6B = black
CM-502G6W = white

Model	CM-502G6B, CM-502G6W	CM-502G12B, CM-502G12W
Polar pattern	supercardioid	supercardioid
System	electret	electret
Audio frequency range	100-18,000 Hz	100-18,000 Hz
Nominal impedance	220 Ω	220 Ω
Sensitivity	4 mV/Pa	4 mV/Pa
Max. sound pressure	125 dB	125 dB
Power supply	= 48 V, phantom power	= 48 V, phantom power
Housing material	metal	metal
Weight	100 g	145 g
Cable	8 m	8 m
Connection	XLR, bal.	XLR, bal.

CM-22G6B

Order No. 0235990

CM-22G6W

Order No. 0233920

CM-22G12B

Order No. 0233930

CM-22G12W

Order No. 0233940

Overhead hanging condenser microphone

- For suspended installations, especially suitable for applications in which a direct microphonic effect is undesired for optical or operational reasons, e.g. sound pickup of choirs or on theatre stages or school stages
- High-quality condenser microphone cartridge with 1.25 cm (1/2") extra thin gold-plated diaphragm, cardioid polar pattern
- Low cut switch (80 Hz)
- 10 dB attenuation, switchable
- Integrated phantom power supply adapter
- Flexible alignment due to gooseneck
- Black (CM-22G...B) or white (CM-22G...W) version
- Supplied with windshield

Total length:

CM-22G6...: 205 mm

CM-22G12...: 340 mm



CM-22G12B = black
CM-22G12W = white

CM-22G6B = black
CM-22G6W = white

Model	CM-22G6B, CM-22G6W	CM-22G12B, CM-22G12W
Polar pattern	cardioid	cardioid
System	condenser	condenser
Audio frequency range	20-20,000 Hz	20-20,000 Hz
Nominal impedance	100 Ω	100 Ω
Sensitivity	15.8 mV/Pa	15.8 mV/Pa
Max. sound pressure	140 dB	140 dB
Power supply	= 48 V, phantom power	= 48 V, phantom power
Housing material	metal	metal
Weight	140 g	160 g
Cable	8 m	8 m
Connection	XLR, bal.	XLR, bal.

CM-602

Order No. 0231930

Electret boundary microphone

- On/off switch with power LED
- Elastic cartridge suspension for preventing impact sound and structure-borne noise
- Integrated electronics for direct connection to a phantom power supply \approx 48 V
- With 6 m connection cable, 3-pole mini XLR/XLR

Model	CM-602
Polar pattern	semi-cardioid
System	electret
Audio frequency range	30-12,000 Hz
Nominal impedance	100 Ω
Sensitivity	2.2 mV/Pa
Max. sound pressure	125 dB
Power supply	\approx 48 V, phantom power
Housing material	plastic
Admiss. ambient temp.	0-40 °C
Weight	88 g
Cable	6 m
Connection	3-pole mini XLR, bal.

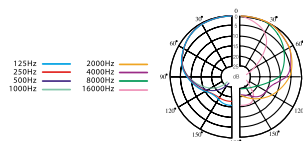
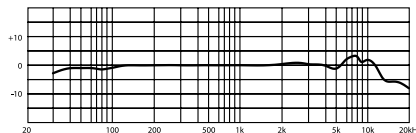

CM-602USB

Order No. 0231870



Electret boundary microphone, with USB port.

- On/off switch with power LED
- Elastic cartridge suspension for preventing impact sound and structure-borne noise
- With 1.8 m USB connection cable

Model	CM-602USB
Polar pattern	semi-cardioid
System	electret
Audio frequency range	30-12,000 Hz
Nominal impedance	100 Ω
Sensitivity	2.2 mV/Pa
Max. sound pressure	125 dB
Power supply	via USB interface
Housing material	plastic
Weight	88 g
Cable	1.8 m
Connection	USB type B jack

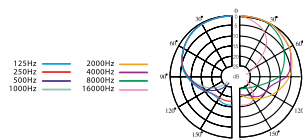
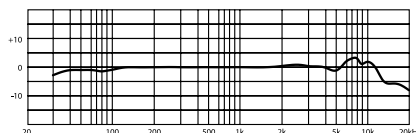

CM-601

Order No. 0235010

Electret boundary microphone

- For theatrical performances, discussions, conferences and in churches
- A direct alignment to the sound source is not essential due to the special characteristics of a boundary microphone
- Dual low cut filter (80 Hz/120 Hz)
- Configurable push-button (PTT, PTM or switching function)
- Standby LED
- Robust and shock-absorbing body
- Elastic cartridge suspension for preventing structure-borne noise and impact sound

Model	CM-601
Transmission method	cable
Polar pattern	semi-cardioid
System	electret
Audio frequency range	30-12,000 Hz
Nominal impedance	100 Ω
Sensitivity	2.2 mV/Pa
Max. sound pressure	125 dB
Power supply	\approx 15-48 V, phantom power
Housing material	diecast metal
Weight	0.269 kg
Connection	XLR, bal.

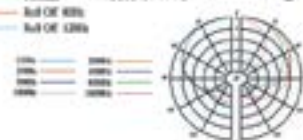
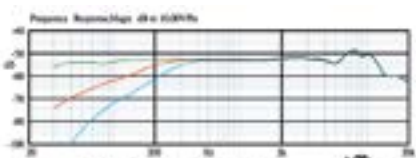



Gooseneck Microphones, Built-in Microphones, Floor Stand Microphones and Desktop Microphones

10

GM-5212DU

Order No. 0236280



GM-5215DU

Order No. 0236300



Double gooseneck microphones

- Back electret supercardioid cartridges
- High sensitivity
- 10 dB attenuator
- Low cut switch
- Flexible positioning due to vertically adjustable goosenecks (160°)
- Common 3-pole XLR plug
- Operation via +48 phantom power

Model	GM-5212DU	GM-5215DU
Polar pattern	supercardioid	supercardioid
System	back electret	back electret
Audio frequency range	80-18,000 Hz	80-18,000 Hz
Nominal impedance	220 Ω	220 Ω
Sensitivity	16 mV/Pa	16 mV/Pa
Max. sound pressure	125 dB	125 dB
Power supply	= 48 V phantom power	= 48 V phantom power
Dimensions	415 mm	492 mm
Weight	315 g	335 g
Connection	XLR, bal.	XLR, bal.

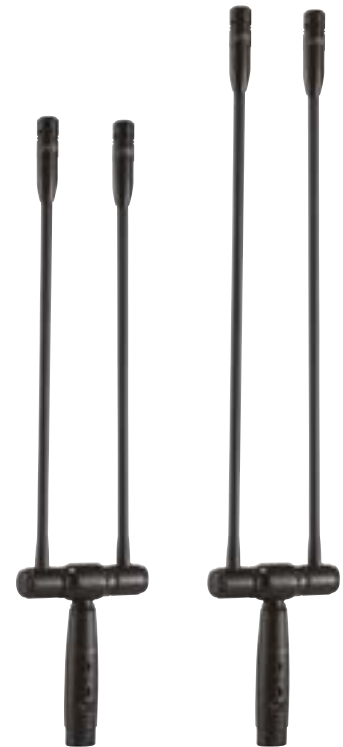

GM-5212LDU

Order No. 0236290



GM-5215LDU

Order No. 0236310



Double gooseneck microphones with LED

- Back electret supercardioid cartridges
- High sensitivity
- 10 dB attenuator
- Low cut switch
- LED for indicating operating status
- Flexible positioning due to vertically adjustable goosenecks (160°)
- Common 3-pole XLR plug
- Operation via +48 V phantom power

Model	GM-5212LDU	GM-5215LDU
Polar pattern	supercardioid	supercardioid
System	back electret	back electret
Audio frequency range	80-18,000 Hz	80-18,000 Hz
Nominal impedance	220 Ω	220 Ω
Sensitivity	16 mV/Pa	16 mV/Pa
Max. sound pressure	125 dB	125 dB
Power supply	= 48 V phantom power	= 48 V phantom power
Dimensions	415 mm	492 mm
Weight	315 g	335 g
Connection	XLR, bal.	XLR, bal.

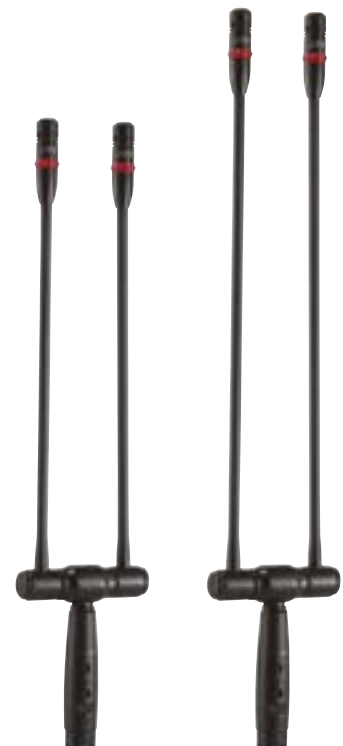

GML-5212

Order No. 0234560

GML-5218

Order No. 0234570

Electret gooseneck microphones with LED

- 3 replaceable microphone cartridges with different polar patterns (cardioid, supercardioid and omnidirectional)
- Excellent speech intelligibility
- -10 dB PAD switch
- Switchable low cut filter
- LED for indicating operating status
- Solid and high-quality workmanship to ensure a long service life
- Gooseneck with integrated 3-pole XLR plug
- Operation via external phantom power or microphone base DMS-5

Model	GML-5212	GML-5218
Polar pattern	cardioid/supercardioid/omnidir.	cardioid/supercardioid/omnidir.
System	back electret	back electret
Audio frequency range	80-18,000 Hz	80-18,000 Hz
Nominal impedance	220 Ω ± 30%	220 Ω ± 30%
Sensitivity	16 mV/Pa	16 mV/Pa
Max. sound pressure	125 dB	125 dB
Power supply	= 48 V phantom power	= 48 V phantom power
Dimensions	465 mm	615 mm
Weight	230 g	245 g
Connection	XLR, bal.	XLR, bal.



GM-5212

Order No. 0234380

GM-5218

Order No. 0234390



Electret gooseneck microphones

- Supercardioid polar pattern
- Excellent sound with a very high speech intelligibility
- Minimum susceptibility to acoustic feedback
- Solid and high-quality workmanship to ensure a long service life
- Gooseneck with integrated 3-pole XLR plug
- Operation via external phantom power or microphone base DMS-5

Model	GM-5212	GM-5218
Polar pattern	supercardioid	supercardioid
System	back electret	back electret
Audio frequency range	80-18,000 Hz	80-18,000 Hz
Nominal impedance	220 Ω ± 30%	220 Ω
Sensitivity	16 mV/Pa	16 mV/Pa
Max. sound pressure	125 dB	125 dB
Power supply	= 48 V phantom power	= 48 V phantom power
Dimensions	455 mm	605 mm
Weight	165 g	185 g
Connection	XLR, bal.	XLR, bal.



GM-5212L

Order No. 0234410

GM-5218L

Order No. 0234420



Electret gooseneck microphones with LED

- Supercardioid polar pattern
- Natural sound
- Frequency response perfectly matched to the voice, precise voice reproduction
- Low susceptibility to acoustic feedback
- LED for indicating operating status
- Solid and high-quality workmanship to ensure a long service life
- Gooseneck with integrated 3-pole XLR plug
- Operation via external phantom power or desktop base DMS-5

Model	GM-5212L	GM-5218L
Polar pattern	supercardioid	supercardioid
System	electret	electret
Audio frequency range	80-18,000 Hz	80-18,000 Hz
Nominal impedance	220 Ω ± 30%	220 Ω
Sensitivity	12.6 mV/Pa	12.6 mV/Pa
Max. sound pressure	125 dB	125 dB
Power supply	= 48 V phantom power	= 48 V phantom power
Dimensions	465 mm	615 mm
Weight	165 g	185 g
Connection	XLR, bal.	XLR, bal.



FGM-170T

Order No. 0231920



FGM-62T

Order No. 0231910



Floor stand microphones, with carbon fibre boom.

- High-quality condenser microphone cartridge with 1.25 cm (½") extra thin gold-plated diaphragm, cardioid polar pattern and excellent sound characteristics
- Low cut switch (80 Hz)
- 10 dB attenuation, switchable
- Extra lightweight (105 g) but very robust carbon fibre boom (1.46 m) with miniature gooseneck
- Structure-borne noise isolated diecast base plate
- Replaceable cartridge unit and cartridge (plug-in system with screw-type locking)
- Supplied with windshield
- Delivery consists of 2 boxes

Model	FGM-170T	FGM-62T
Polar pattern	cardioid	cardioid
System	condenser	condenser
Audio frequency range	20-20,000 Hz	20-20,000 Hz
Nominal impedance	100 Ω	100 Ω
Sensitivity	15.8 mV/Pa	15.8 mV/Pa
Max. sound pressure	140 dB	140 dB
Power supply	= 48 V, phantom power	= 48 V, phantom power
Dimensions	1.46 m (boom) 1.6 m (stand)	1.46 m (boom) 0.6 m (stand)
Weight	3.4 kg	3.2 kg
Connection	3-pole XLR plug, bal.	3-pole XLR plug, bal.

FGM-170T: with long shaft, for overhead miking
FGM-62T: with short shaft, for front miking

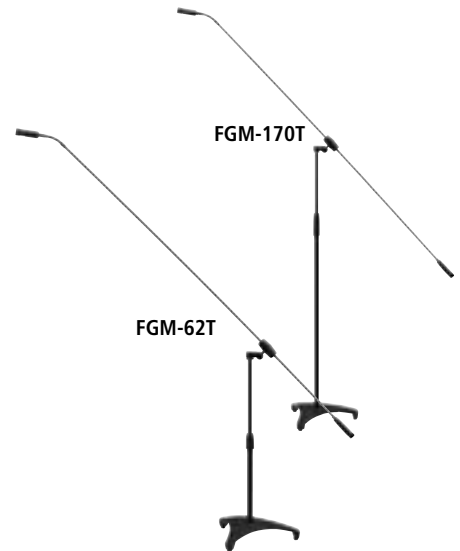

FGM-170

Order No. 0236070



FGM-62

Order No. 0236080



Floor stand microphones, with carbon fibre boom.

- 3 high-quality back electret microphone cartridges with different polar patterns
- Low cut switch (80 Hz)
- 10 dB attenuation, switchable
- Extra lightweight (105 g) but very robust carbon fibre boom (1.46 m) with miniature gooseneck
- Structure-borne noise isolated diecast base plate
- Supplied with 2 replacement cartridges, connection cable and windshield
- Delivery consists of 2 boxes

Model	FGM-170	FGM-62
Polar pattern	cardioid, supercardioid, omnidir.	cardioid, supercardioid, omnidir.
System	back electret	back electret
Audio frequency range	50-18,000 Hz	50-18,000 Hz
Nominal impedance	220 Ω	220 Ω
Sensitivity	16 mV/Pa	16 mV/Pa
Max. sound pressure	125 dB	125 dB
Power supply	= 12-48 V, phantom power	= 12-48 V, phantom power
Dimensions	1.46 m (boom) 1.6 m (stand)	1.46 m (boom) 0.6 m (stand)
Weight	3.6 kg	3.2 kg
Connection	cable with 3-pole mini XLR to XLR	cable with 3-pole mini XLR to XLR

FGM-170: with long shaft, for overhead miking
FGM-62: with short shaft, for front miking

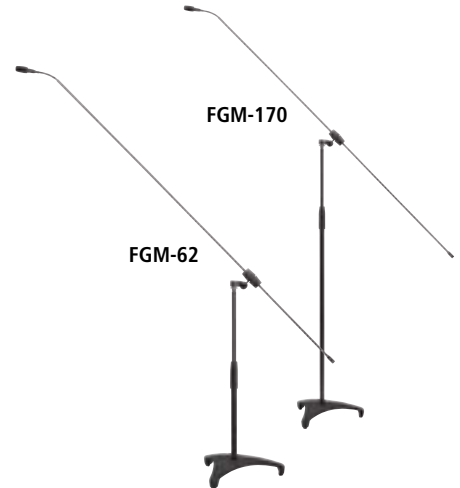

CM-503U/B

Order No. 0231710

CM-503U/W

Order No. 0231820

Built-in electret microphones

- Microphone cartridge with semi-cardioid polar pattern
- Compact boundary microphone
- Low cut switch (80 Hz)
- 10 dB attenuation, switchable
- Metal housing
- Black (CM-503U/B) or white (CM-503U/W) cartridge cover

Model	CM-503U/B, CM-503U/W
Polar pattern	semi-cardioid
System	electret
Audio frequency range	40-12,000 Hz
Nominal impedance	220 Ω
Sensitivity	4 mV/Pa
S/N ratio	70 dB
Max. sound pressure	140 dB
Power supply	= 9-52 V, phantom power
Housing material	metal
Dimensions	31.6 x 69.7 x 30 mm
Weight	67 g
Connection	XLR, bal.



CM-503N/B

Order No. 0231720

CM-503N/W

Order No. 0231730

Built-in electret microphones

- Microphone cartridge with omnidirectional polar pattern
- Compact boundary microphone
- Low cut switch (80 Hz)
- 10 dB attenuation, switchable
- Metal housing
- Black (CM-503N/B) or white (CM-503N/W) cartridge cover

Model	CM-503N/B, CM-503N/W
Polar pattern	omnidir.
System	electret
Audio frequency range	40-17,000 Hz
Nominal impedance	220 Ω
Sensitivity	4 mV/Pa
S/N ratio	68 dB
Max. sound pressure	140 dB
Power supply	= 9-52 V, phantom power
Housing material	metal
Dimensions	31.6 x 69.7 x 30 mm
Weight	67 g
Connection	XLR, bal.



Desktop Microphones

ST-850

Order No. 0235510

Gooseneck microphone for an optional wireless operation

- Matching pocket transmitters of the PT series
- High-quality back electret cartridge with supercardioid polar pattern
- Low-noise reed switch for on/off
- LED status indicator
- Solid diecast housing
- Opt. pocket transmitter can be attached to diecast base

Model	ST-850
Polar pattern	supercardioid
System	back electret
Audio frequency range	50-18,000 Hz
Nominal impedance	2 k Ω /100 Ω
Sensitivity	5 mV/Pa, 15.8 mV/Pa
Max. sound pressure	125 dB
Power supply	via pocket transmitter, +48 V phantom power
Gooseneck length	305 mm
Dimensions	110 x 65 x 150 mm
Weight	693 g
Connection	4-pole mini XLR inline jack, XLR panel plug



ST-5000T

Order No. 0236890



Gooseneck desktop microphone

- 1.25 cm (1/2") high-quality gold-plated condenser cartridge
- Low cut switch (80 Hz)
- 10 dB attenuation, switchable
- Low-noise ON/OFF button
- Power LED
- XLR output

Model	ST-5000T
Polar pattern	cardioid
System	condenser
Audio frequency range	20-20,000 Hz
Nominal impedance	100 Ω
Sensitivity	15.8 mV/Pa
S/N ratio	78 dB
Max. sound pressure	140 dB
Power supply	= 36-52 V, phantom power
Gooseneck length	122 mm
Dimensions	96 x 46 x 113 mm
Weight	748 g
Connection	XLR, bal.



ST-5000

Order No. 0231900



Gooseneck desktop microphone

- Back electret, supercardioid polar pattern
- Special RF shielding to avoid audible interference from smartphones
- ON/OFF switch
- Power LED
- Heavy-duty version
- Supplied with windshield

Model	ST-5000
Polar pattern	supercardioid
System	back electret
Audio frequency range	80-18,000 Hz
Nominal impedance	220 Ω
Sensitivity	10 mV/Pa
Max. sound pressure	125 dB
Power supply	= 12-48 V, phantom power
Gooseneck length	368 mm
Dimensions	96 x 46 x 113 mm (console housing)
Weight	820 g
Connection	XLR, bal.



ST-5030

Order No. 0234360



Desktop microphone base for gooseneck microphone

- Anti-slip coating at the bottom for a firm stand and for noise reduction
- High-quality on/off reed switch allows almost silent switching operation
- Selector switch at the bottom for choosing type of microphone used (electret/dynamic)
- Operation possible via +48 V phantom power or two 1.5 V batteries AA size (not supplied)

Model	ST-5030
Power supply	48 V phantom power or 2 x 1.5 V batt. AA size (not supplied) 0.88 mA (operation) 0.62 mA (standby)
Weight	1.1 kg
Connections	XLR, bal. (in/out)



ST-5070

Order No. 0348240

Shock-mount base with XLR socket

- Elastic rubber support for suppressing low-frequency structure-borne noise
- Solderless version with screw terminal
- Latching device to avoid accidental unplugging of gooseneck microphone

Model	ST-5070
Dimensions	82 x 43 x 86 mm
Weight	67 g
Connections	XLR jack, screw terminal





Accessories for Microphones

11

PS-510M

Order No. 0236720

Phantom power supply adapter/mixer, battery-operated

- For supplying power to two microphones with 4-pole mini XLR plug (e.g. CX...W series, headband microphones and lavalier microphones of the CX/CM series)
- Allows operation at mixers, home recorders or similar devices without integrated +48 V phantom power
- Separate volume controls for the two microphones
- Adjustable headphone output
- Mute switch
- Belt clip

Model	PS-510M
Input voltage	9 V battery (not supplied) or 12-48 V phantom power
Connections	2 x 4-pole mini XLR (input) 1 x XLR, bal. (output) 1 x 3.5 mm jack (headphones)
Dimensions	65 x 92 x 30 mm
Weight	80 g



PS-500

Order No. 0235080

Phantom power supply adapter/mixer, battery-operated

- For supplying power to two microphones with 4-pole mini XLR plug (e.g. CX...W series, headband microphones and lavalier microphones of the CX/CM series)
- Allows operation at mixers, home recorders or similar devices without integrated +48 V phantom power
- Separate volume controls for the two microphones

Model	PS-500
Input voltage	9 V battery (not supplied)
Connections	IN: 2 x 4-pole mini XLR OUT: 1 x XLR, bal.
Weight	81 g



MA-123

Order No. 0235490

Adjustable attenuator for balanced microphones

- For matching the microphone signal to mixers or preamplifiers
- Attenuation: 10 dB, 20 dB, 30 dB
- Also suitable for microphones with phantom power
- Metal body

Model	MA-123
Frequency range	22-20,000 Hz
Input impedance	1.6 k Ω -10 dB
Output impedance	660 Ω -10 dB
Dimensions	\varnothing 21 mm x 113 mm
Weight	46 g
Inputs	3-pole XLR jack
Outputs	3-pole XLR plug



MA-500

Order No. 0235890

Phantom power supply adapter

- For electret microphones of the CM and CX series with 4-pole mini XLR connection
- 10 dB attenuator
- 2 switchable low cut filters
- Metal body with belt clip

Model	MA-500
Input voltage	= 12-48 V
Output voltage	= 12-48 V
Connections	4-pole mini XLR (microphone), 3-pole XLR (mixer)
Dimensions	\varnothing 20 mm x 96 mm
Weight	41 g



MA-SW

Order No. 0236520

In-line microphone switch

- For dynamic microphones and condenser microphones
- Bi-directional use
- Metal body

Model	MA-SW
Dimensions	\varnothing 21 mm x 113 mm
Weight	44 g
Connections	3-pole XLR jack, 3-pole XLR plug



MA-PRS

Order No. 0236510

In-line phase reverser

- For balanced signals
- Bypass for phantom power
- Bi-directional use
- Metal body

Model	MA-PRS
Dimensions	Ø 21 mm x 113 mm
Weight	44 g
Connections	3-pole XLR jack, 3-pole XLR plug



MA-HPF

Order No. 0236500

In-line high-pass filter

- For reducing low-frequency microphone signals
- Also suitable for microphones with phantom power
- Metal body

Model	MA-HPF
Output impedance	150 Ω
Low cut	100 Hz (12 dB/oct.)
Dimensions	Ø 21 mm x 113 mm
Weight	50 g
Inputs	3-pole XLR jack
Outputs	3-pole XLR plug



MH-56

Order No. 0234730

Microphone holder for wireless microphones

- Suitable for wireless microphones
- Special composition of plastic materials guarantees high flexibility at an optimum form stability
- Rubber surround protects microphone from scratches and allows for a secure fit
- For tripod sockets: 9 mm (3/8") or 16 mm (5/8")



MH-36

Order No. 0234720

Microphone holder for standard microphones

- Suitable for microphones NX-7, NX-8
- Special composition of plastic materials guarantees high flexibility at an optimum form stability
- For tripod sockets: 9 mm (3/8") or 16 mm (5/8")



MH-16

Order No. 0234740

Microphone holder for slimline microphones

- Suitable for microphones NX-8.8 and NX-9
- Special composition of plastic materials guarantees high flexibility at an optimum form stability
- For tripod sockets: 9 mm (3/8") or 16 mm (5/8")



MH-22

Order No. 0236860

Microphone holder

- Suitable for microphones JS-22, NX-9, CX-509 or similar models
- Good structure-borne noise isolation due to soft suspension
- For tripod sockets: 16 mm (5/8")



CLP-6

Order No. 0235060

Microphone holder

- Robust clamp allows for a secure attachment of microphone NX-6 to the rim of e.g. toms or snare drums
- Precise and optimum positioning of the microphones
- Microphone to be screwed directly to clamp



GC-80

Order No. 0067070

Guitar/bass cable

- For connecting an electric guitar to pocket transmitters of the PT/IN/UF series
- 6.3 mm metal plug with cable bending protection and 4-pole mini XLR inline jack with self-latching device
- Length: 70 cm



Range of Applications for Microphones

Model	Page	Speech / Presentations	Vocals (solo)	Vocals (choir)	Drums / Percussion	Guitar amps	Bass amps	Acoust. Bass instruments	Wind instruments	Acoustic guitars	Bow instruments	Piano / Grand piano	Accordion	Harmonica	Film production / Features
CM-125IB	J29	•	•												
CM-125IF	J29	•	•												
CM-214F	J27	•	•												
CM-214U	J27	•	•												
CM-214ULF	J27	•	•												
CM-22G6B	J40			•											
CM-22G6W	J40			•											
CM-22G12B	J40			•											
CM-22G12W	J40			•											
CM-235IB	J27	•	•												
CM-235IF	J27	•	•												
CM-501	J28	•													
CM-502	J39	•		•											
CM-502G6B	J40			•											
CM-502G6W	J40			•											
CM-502G12B	J40			•											
CM-502G12W	J40			•											
CM-502WT	J39	•		•											
CM-503N/B	J45	•													
CM-503N/W	J45	•													
CM-503U/B	J45	•													
CM-503U/W	J45	•													
CM-601	J41	•		•					•	•		•	•		
CM-602	J41	•		•					•	•		•	•		
CM-602USB	J41	•		•					•	•		•	•		
CM-801F	J28	•	•												
CM-804IF	J28	•	•												
CX-500	J31								•	•	•				
CX-500F	J31								•						
CX-500DUSET	J31							•		•	•	•			
CX-500FHW	J31								•						
CX-505	J32				•										
CX-508	J32								•						
CX-508W	J32								•						
CX-509	J39			•	•					•	•				
CX-516	J32								•		•	•	•		
CX-516W	J32								•		•	•	•		
CX-520	J32													•	
FGM-170T	J45	•	•	•	•	•			•	•	•	•			
FGM-62T	J45	•	•	•	•	•			•	•	•	•			
FGM-62/170	J45	•	•	•	•	•			•	•	•	•			
GM(L)	J43-J44	•													
JS-1E	J34		•	•				•		•	•				
JS-22	J39			•	•			•	•	•	•	•			
KA-8TH/1	J61	•													•
KA-10/1PACK	J61	•													•
NX-2	J33				•		•	•	•			•			
NX-6	J33				•		•		•	•		•			
NX-8	J34	•	•	•											
NX-8S	J34	•	•	•											
NX-8.8	J34	•	•	•											
NX-9	J33	•	•	•	•				•	•	•	•	•		
PDM-3	J36	•	•	•											
PDM-57	J39				•	•	•		•	•	•	•	•	•	
SGM-14	J39	•													•
ST-850	J46	•													
ST-5000	J46	•													
TK-350	J35	•	•	•											
TK-600	J35	•	•	•											
TM-929	J36	•	•	•											
TM-969	J35	•	•	•											
TM-989	J35	•	•	•											



Conference Systems, Microphone Mixers and Interpretation Systems

12

CS-W4C/5

Order No. 1000017



4-channel diversity UHF PLL wideband receiver for conference system

- Bandwidth: 36 MHz
- 6 groups, each with up to 22 compatible preset channels
- 1,441 selectable individual frequencies
- RF output and mains voltage output for easily cascading up to 10 x CS-W4C/5 receiver without additional splitter
- REMOSET technology for receiver/transmitter synchronisation
- Removable antennas (BNC connection)
- Auto-scan function
- Pilot tone squelch and noise mute
- Backlit display for indicating the status, e.g. for group/channel, frequency, battery, antenna A/B
- LED for indicating RF level and AF level
- Link connections
- Trigger output
- 482 mm (19") rack installation, 1 RS

There are restrictions or requirements within the EU!

Please read the notes regarding wireless systems in the section "IMPORTANT INFORMATION"!



Model	CS-W4C/5
Carrier frequency range	626-662 MHz
Audio frequency range	60-16,000 Hz
THD	< 0.6%
Dynamic range	> 105 dBA
Audio signal receiver	630 mV/600 Ω XLR (line), 63 mV/600 Ω XLR (mic), 316 mV/600 Ω jack
Power supply receiver	~ 110-240 V/50-60 Hz/20 VA
Dimensions receiver	485 x 45 x 260 mm
Weight receiver	2.4 kg

CS-W4T/5

Order No. 1000018



UHF PLL microphone desk stand transmitter for the chairperson

- Back-electret microphone cartridge, supercardioid polar pattern
- 400 mm gooseneck, removable
- REMOSET technology for receiver/transmitter synchronisation
- Adjustable sensitivity
- Switchable transmitting power
- Low cut function
- Automatic switch-off
- Lock function
- LCD for indicating group/channel, audio level and battery status

There are restrictions or requirements within the EU!

Please read the notes regarding wireless systems in the section "IMPORTANT INFORMATION"!



Model	CS-W4T/5
Carrier frequency range	626-662 MHz
Transmitting power	10/50 mW
Operating time	≈ 25 h
Audio frequency range	60-16,000 Hz
Power supply	2 x batt. AA size, alkaline (not supplied)
Gooseneck length	400 mm
Dimensions	138 x 29 x 116 mm (console housing)
Weight	760 g

W4-CH1

Order No. 1000019



Charging station, for a UHF PLL microphone desk stand transmitter CS-W4T.

- Average charging time, depending on condition of rechargeable batteries used: approx. 3 hours
- LED for indicating battery charging status
- Mechanical reverse polarity protection
- Protection against overload, short-circuit and deep discharge

Supplied w/o devices.

**W4-CH12**

Order No. 1000020



Transport case with integrated charging function, for UHF PLL microphone desk stand transmitter CS-W4T.

- For simultaneously charging rech. batteries of up to 12 devices
- Average charging time, depending on condition of rechargeable batteries used: approx. 5 hours
- Each slot with LED for indicating battery charging status
- Mechanical reverse polarity protection
- Protection against overload, short-circuit and deep discharge

Supplied w/o devices.

**W4-CH12/COVER**

Order No. 1000021



Transport case cover

- Suitable for transport case with integrated charging function W4-CH12.



Conference System CS-1

Your opinion will be heard! The control unit CS-1CU, the microphone station for the chairperson CS-1CH and the microphone station for conference delegates CS-1DU together form a conference system with extensive configuration facilities for maximum flexibility.



CS-1CU

Order No. 0173060

Control unit, the control centre of the conference system

- For setting up a system with up to 50 microphone stations (2 x 25)
- Power supply for microphone stations
- Built-in speaker
- Headphone connection
- Keypad lock
- Display of date/time
- Stopwatch
- Test function for connected microphone stations
- Connection facilities for optional devices, e.g. external microphone, telephone coupler, signal processing units (e.g. equalizer), recorders, amplifiers, audio line sources

Model	CS-1CU
Power supply	100-240 V~/50-60 Hz/90 VA
Dimensions	360 x 90 x 150 mm
Weight	1.7 kg
Connections	2 x RCA (input/output for telephone coupler) 2 x RCA (input/output, e.g. for equalizer) 2 x RCA L/R (input/output for recorder) 2 x RCA (input/output for line signals) 1 x XLR (microphone input) 2 x 7-pole DIN jack (connection for microphone stations)

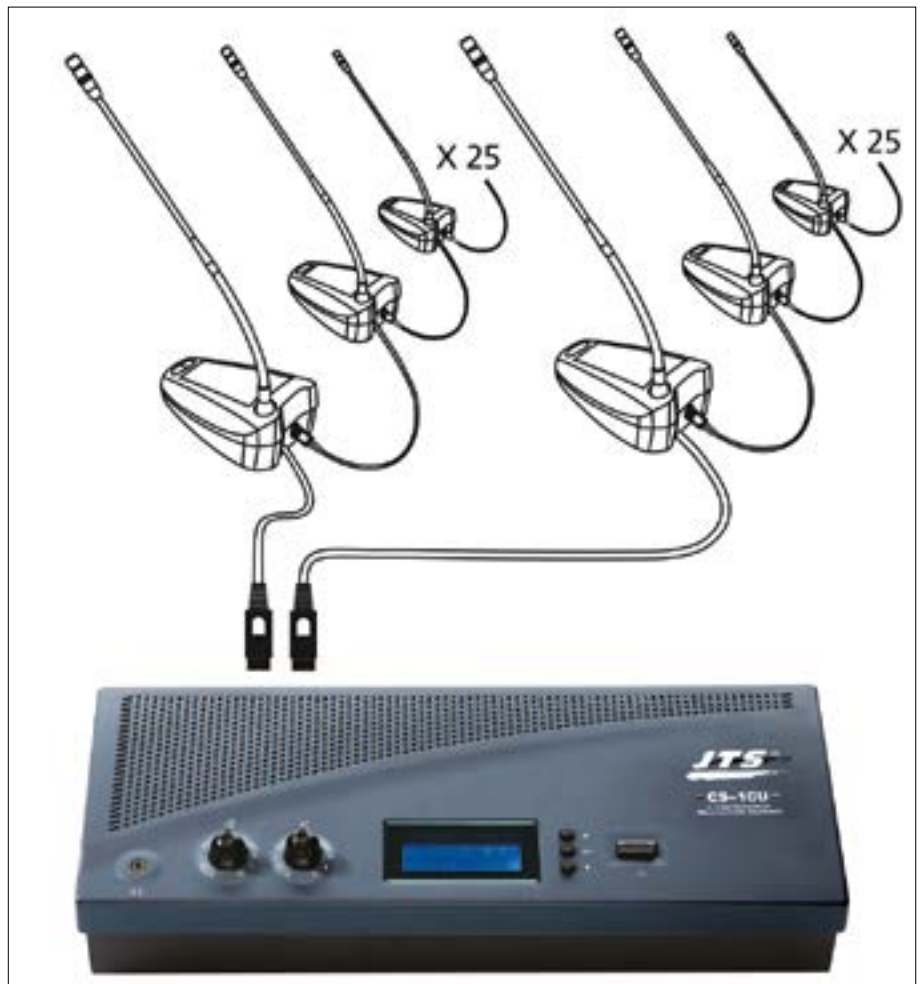

CS-1CH

Order No. 0173070

Microphone station for chairperson

- Back electret cartridge with cardioid polar pattern, optimised for voice transmissions
- Low-distortion speaker
- Reproduction via optional headphones
- Large function button
- Status displays at microphone and desktop station
- Priority button allows to interrupt an ongoing discussion between conference delegates, alternatively with a chime

Model	CS-1CH
Polar pattern	cardioid
System	back electret
Audio frequency range	50-18,000 Hz
Power supply	via control unit CS-1CU
Gooseneck length	400 mm
Dimensions	115 x 65 x 170 mm (console housing)
Weight	1.1 kg
Cable	2 m
Connection	2 x 3.5 mm jack 1 x 2 m connection cable with 7-pole DIN plug 1 x 7-pole DIN jack



CS-1DU

Order No. 0173080

Microphone station for conference delegates

- Back electret cartridge with cardioid polar pattern, optimised for voice transmissions
- Low-distortion speaker
- Operation via function button
- Headphone connection
- Status displays at microphone and desktop station

Model	CS-1DU
Polar pattern	cardioid
System	back electret
Audio frequency range	50-18,000 Hz
Power supply	via control unit CS-1CU
Gooseneck length	400 mm
Dimensions	115 x 65 x 170 mm (console housing)
Weight	1.1 kg
Cable	2 m
Connection	2 x 3.5 mm jack 1 x 2 m connection cable with 7-pole DIN plug 1 x 7-pole DIN jack



D7P-10

Order No. 0173370

10 m

Extension cable

- 7-pole DIN plug to 7-pole DIN jack
- Length: 10 m



D7P-20

Order No. 0173380

20 m

Extension cable

- 7-pole DIN plug to 7-pole DIN jack
- Length: 20 m



The Automatic Microphone Mixers

of the CS series are THE perfect aid for concepts with multiple microphones, e.g. in conference rooms, churches or language laboratories. The main task of the mixer is to open the respective microphone channel when required and to close it again when the speaker has finished the presentation. This intelligent adjustment for the individual microphone channels allows for a silent and precise control which ensures that the audience hears every single word. This greatly improves the overall sound resulting in a clear, transparent reproduction and minimises acoustic feedback and irritating background noise. The CS mixers feature a last-in function in order to maintain a pleasant atmosphere with a soft ambient sound also during the breaks in conversation rather than just cutting off the sound.

CS-8

Order No. 0173550

Automatic microphone mixer

- 8 channels
- 3 operating modes: auto mode, priority or 8/1-channel mixer
- Balanced XLR inputs, switchable mic/line
- Additional stereo RCA input
- 48 V phantom power
- Mix output, switchable mic/line
- Trigger outputs for external devices, e.g. warning devices, cameras or speakers
- Status LEDs
- Several devices can be combined via link connections (supplied with cable)
- Desktop metal housing
- 482 mm (19") rack installation possible with supplied mounting brackets

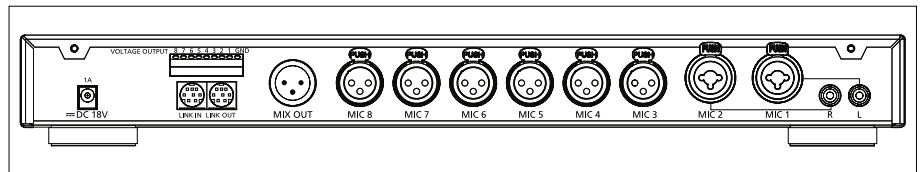

Model	CS-8
Mic input	0.2 mV/4.7 kΩ
Line input	60 mV/20 kΩ
Aux output	1 V/200 Ω
Frequency range	35-20,000 Hz
THD	< 0.06%
S/N ratio	> 70 dB
Power supply	via encl. plug-in power supply
Dimensions	420 x 44 x 199 mm
Weight	2.3 kg

CS-4

Order No. 0173540

Automatic microphone mixer

- 4 channels
- 3 operating modes: auto mode, priority or 4/1-channel mixer
- Balanced XLR inputs, switchable mic/line
- 12 V phantom power
- Mix output, switchable mic/line
- Trigger outputs for external devices, e.g. warning devices, cameras or speakers
- Status LEDs
- Several devices can be combined via link connections (supplied with cable)
- Desktop metal housing
- 482 mm (19") rack installation with supplied mounting brackets

Model	CS-4
Mic input	0.2 mV/4.7 kΩ
Line input	60 mV/20 kΩ
Aux output	1 V/200 Ω
Frequency range	35-20,000 Hz
THD	< 0.06%
S/N ratio	> 70 dB
Power supply	via encl. plug-in power supply
Dimensions	200 x 44 x 212 mm
Weight	1.4 kg

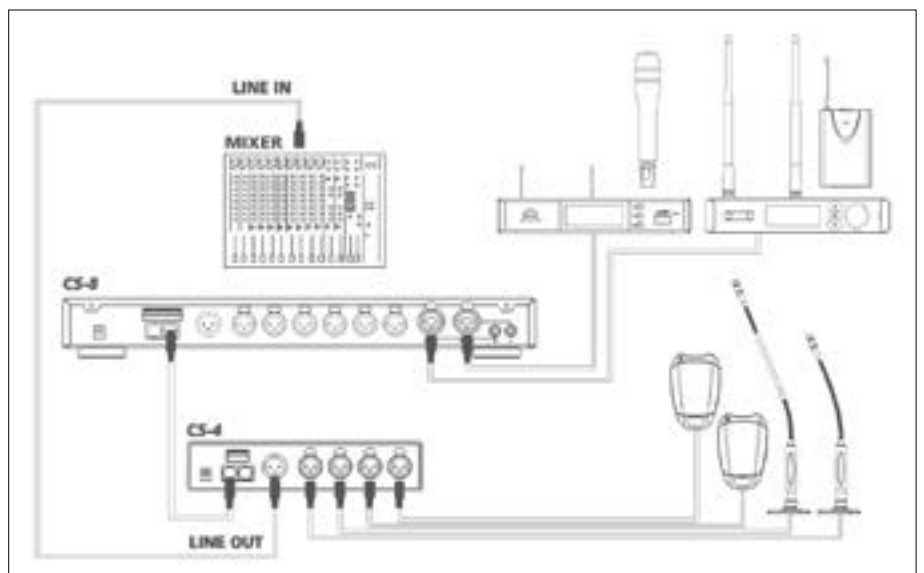
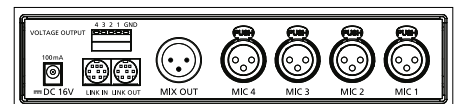



IT-12M

Order No. 0173720

Interpretation system, base unit, for setting up a multilingual interpretation system.

- 12 languages (floor language/main language and 11 translations via interpretation console IT-12D)
- Slow-down signal
- Alarm function, audio message or audio alarm signal can be fed to each output

- Status LEDs for interpretation channels
- Microphone connection via comb. jack on the front panel
- 48 V phantom power supply
- 12 V power supply connections for wireless transmitters TG-10STX/1, available at option
- 482 mm (19") rack installation with supplied mounting brackets

Model	IT-12M
Description	interpretation system, base unit
Type	12 languages
Colour	black
Material	metal
Power supply	~ 230 V/50 Hz/90 VA
Dimensions	423 x 52 x 220 mm
Weight	2.6 kg
Connections	microphone connection (comb. jack), 12 V power supply connections for TG-10STX/1

IT-12D

Order No. 0173710

Interpretation console, as an addition to the base unit IT-12M.

- Up to 11 interpretation consoles can be cascaded
- 2 channels, one of which is active, the other serves as a standby channel
- Interpreting channels can be stored permanently at the console
- Last active channel will be stored after switching off the operating voltage and will be available again immediately after switching on the unit
- 2 simultaneous interpreters/commentators to use the active channel at the same time
- Headset connection with volume control
- Microphones can be switched off or muted, cough button
- Balanced XLR jacks for connecting additional microphones
- Relay interpreting via 11-step language selector
- Low-noise push-buttons for switching between relay language and floor language



- Protocol of interpretation via 2 record outputs
- Slow-down button
- Robust and stable metal housing
- Power supply via base unit

Model	IT-12D
Description	interpretation console
Type	2 channels
Colour	black
Material	metal
Suitable for	IT-12M
Power supply	via IT-12M
Dimensions	330 x 56 x 206 mm
Weight	2.3 kg
Connections	headset connection, bal. XLR jacks, record outputs

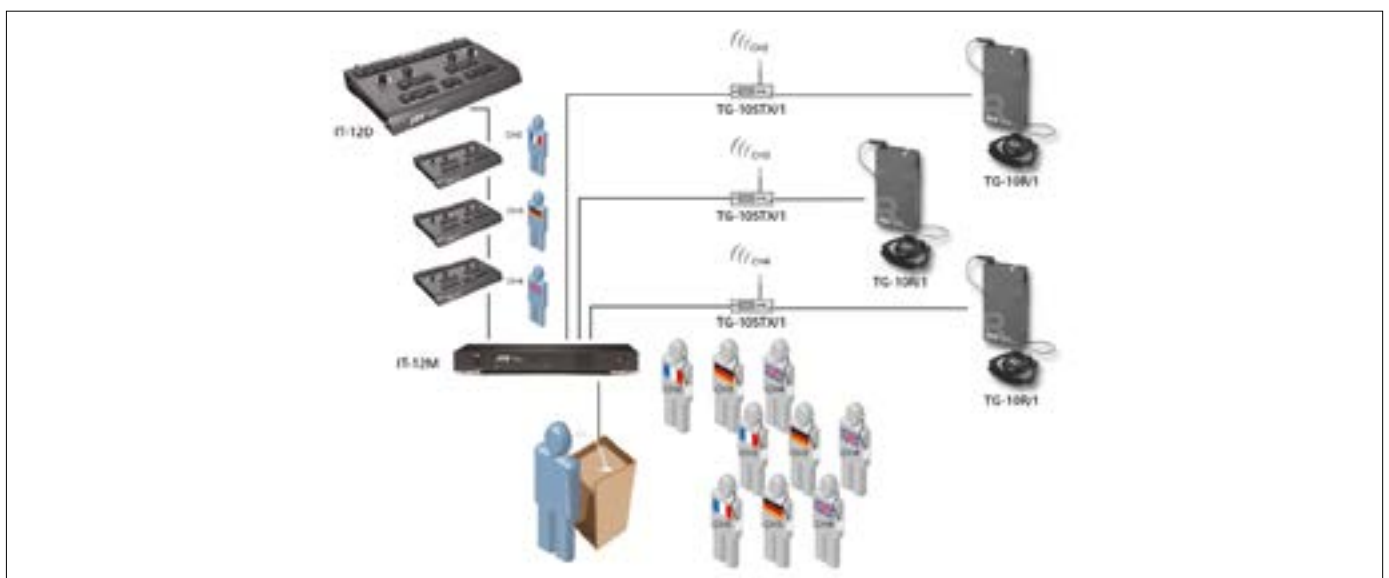



Tour Guide Systems

13

Professional PLL Tour Guide System

- Bandwidth: 36 MHz
- 6 groups with up to 22 channels
- 124 channels
- 506-542 MHz
- Operating range: up to 200 m
- Operating time: approx. 10 hours
- There are restrictions or requirements within the EU!

TG-98TA/5

Order No. 0257410

Professional PLL pocket transmitter

- Built-in electret microphone
- 3.5 mm microphone connection
- Supplied with matching electret tie clip microphone
- Audio input via 3.5 mm jack
- LCD for indicating channel/group, RF, mute and battery status
- Lock function
- Mute function
- Volume level control
- Selectable transmitting power
- Belt clip and lanyard
- Parallel operation possible of up to 22 transmitters max.

There are restrictions or requirements within the EU!

Please read the notes regarding wireless systems in the section "IMPORTANT INFORMATION"!

Model	TG-98TA/5
Carrier frequency range	506-542 MHz
Audio frequency range	40-18,000 Hz
Operating range	200 m
Power supply transmitter	2 x 1.2 V NiMH rech. batt. AA size (not supplied)
Dimensions transmitter	62 x 112 x 28 mm
Weight transmitter	72 g
Connections transmitter	1 x 3.5 mm jack (microphone), 1 x 3.5 mm jack (audio input)



TG-98RA/5

Order No. 0257400

Professional PLL pocket receiver

- Built-in speaker
- 3.5 mm headphone connection
- Supplied with matching clip-on earphone with rubber ear hook
- Audio output via 3.5 mm jack
- LCD for indicating channel/group, RF and battery status
- Limiter function
- Automatic switch-off (power-saving function)
- Volume level control
- Belt clip and lanyard

There are restrictions or requirements within the EU!

Please read the notes regarding wireless systems in the section "IMPORTANT INFORMATION"!

Model	TG-98RA/5
Carrier frequency range	506-542 MHz
Audio frequency range	40-18,000 Hz
Operating time	10 h
Power supply receiver	2 x 1.2 V NiMH rech. batt. AA size (not supplied)
Dimensions receiver	62 x 112 x 28 mm
Weight receiver	72 g
Connections receiver	1 x 3.5 mm jack (headphones), 1 x 3.5 mm jack (audio output)



16-channel PLL Tour Guide System, 863-865 MHz

- With extensive accessories
- Operating range: up to 60 m
- Parallel operation of up to three wireless transmitters
- Licence-free in the EU

TG-10STX/1

Order No. 0173730

16-channel PLL wireless transmitter

- 2 inputs (CH1/CH2) via rear comb. jacks, with level controls
- 1 input (CH3) via 6.3 mm mono jack
- Continuously adjustable headphone output
- 2 loop outputs
- Phantom power can be activated as required

Model	TG-10STX/1
Carrier frequency range	863-865 MHz
Audio frequency range	40-15,000 Hz
Operating range	60 m
Power supply transmitter	via encl. power supply
Dimensions transmitter	214 x 45 x 240 mm
Weight transmitter	1.3 kg
Connections transmitter	2 x comb. jack (input CH1/CH2), 1 x 6.3 mm mono jack (input CH3), 1 x 3.5 mm stereo jack (headphones), 2 x 6.3 mm mono jack (loop outputs)



Licence-free in the EU.

TG-10T/1

Order No. 0253080

PLL pocket transmitter

- Built-in electret microphone
- 3.5 mm microphone connection
- Supplied with matching earband microphone CM-801F
- Channel selector button
- LED channel indicator
- Volume level control
- Belt clip and lanyard

Model	TG-10T/1
Carrier frequency range	863-865 MHz
Audio frequency range	40-18,000 Hz
Operating range	60 m
Power supply transmitter	rech. lithium-ion batt. 3.7 V/1,300 mAh
Dimensions transmitter	54 x 99 x 17 mm
Weight transmitter	80 g
Connections transmitter	1 x 3.5 mm jack (microphone)



Licence-free in the EU.

TG-10R/1

Order No. 0253070

PLL pocket receiver

- 3.5 mm headphone connection
- Supplied with matching earphone with rubber ear hook
- Channel selector button
- LED channel indicator
- Volume level control
- Belt clip and lanyard

Model	TG-10R/1
Carrier frequency range	863-865 MHz
Audio frequency range	40-18,000 Hz
Operating time	12 h
Power supply receiver	rech. lithium-ion batt. 3.7 V/1,300 mAh
Dimensions receiver	54 x 99 x 17 mm
Weight receiver	80 g
Connections receiver	1 x 3.5 mm jack (headphones)



Licence-free in the EU.

Induction loop NL-90 for signal transmission to a hearing device available at option.

KA-10/1PACK

Order No. 0253120

Wireless 16-channel PLL audio transmission system for cameras

- Consisting of a portable audio transmitter and receiver
- Carrier frequency range: 863-865 MHz
- Transmitter and receiver with rechargeable lithium-ion batteries for reducing the weight and to ensure long operating times
- Transmitter can also be used for transmitting line signals (adjustment via recessed gain control)
- Receiver with 3-step PAD switch (0dB/-10 dB/-20 dB) for perfect level matching to the audio input of the camera
- Transmitter and receiver are fitted with a robust metal fixing clip
- Operating time: approx. 12 hours
- Supplied with lavalier microphone in skin design with windshield and tie clip, attachment clip for camera mounting, trim key, dual charging slot with

Model	KA-10/1PACK
Description	16-channel PLL audio transmission system
Carrier frequency range	863-865 MHz
Audio frequency range	40-18,000 Hz
THD	< 1%
Transmitting power	< 10 mW
Operating range	approx. 60 m
Power supply transmitter	3.7 V rech. lithium-ion battery
Dimensions transmitter	55 x 100 x 18 mm
Weight transmitter	80 g
Audio signal receiver	300 mV/7 kΩ (jack)
Power supply receiver	3.7 V rech. lithium-ion battery
Dimensions receiver	55 x 100 x 18 mm
Weight receiver	82 g
Connections receiver	1 x 3.5 mm jack (transmitter) 1 x 3.5 mm jack (receiver)

plug-in switch-mode power supply, connection cable with 3.5 mm plug to 3.5 mm plug, connection cable with 3.5 mm plug to XLR plug

**Licence-free in the EU.
Supplied w/o camera.**



KA-8TH/1

Order No. 0254410

Hand-held UHF PLL transmitter

- Matching the wireless 16-channel PLL audio transmission system for cameras KA-10/1PACK or the PLL pocket receiver TG-10R/1
- Condenser cartridge with cardioid polar pattern
- Adjustable sensitivity
- Mute function
- Battery status indication and LCD for indicating channel

Licence-free in the EU.

Model	KA-8TH/1
Polar pattern	cardioid
System	condenser
Carrier frequency range	863-865 MHz
Transmitting power	10 mW
Power supply	2 x batt. AA size, alkaline (not supplied)
Operating time	approx. 20 h
Audio frequency range	40-16,500 Hz
Power supply	2 x 1.5 V batt. AA size
Dimensions	Ø 51 mm x 260 mm
Weight	216 g



BAG-ARM/S

Order No. 0236460

Arm bag

- Suitable for components TG-10T/1 and TG-10R/1 of the tour guide system
- Ideally suited for mobile applications
- Flexible, adjustable strap
- Removable bag with hook and loop fastener



BAG-BELT/S

Order No. 0236480

Belt bag

- Suitable for components TG-10T/1 and TG-10R/1 of the tour guide system
- Ideally suited for mobile applications
- Flexible, adjustable strap
- Removable bag with hook and loop fastener



TG-10CH2

Order No. 0252670

Charging station for transmitters TG-10T/1 and receivers TR-10R/1 as well as for KA-10 components.

- For simultaneously charging rech. batteries of 2 devices
- Average charging time, depending on condition of rechargeable batteries used: approx. 8 hours
- Each slot with LED for indicating battery charging status
- Mechanical reverse polarity protection
- Protection against overload, short-circuit and deep discharge

Supplied w/o devices.

Model	TG-10CH2
Suitable for	2 x TG-10T/1, TG-10R/1, KA-10 components
Power supply	via encl. power supply
Dimensions	75 x 41 x 85 mm
Weight	485 g



TG-10CH18

Order No. 0252660

Transport case with integrated charging function, for transmitters TG-10T/1 and receivers TG-10R/1 as well as for KA-10 components.

- For simultaneously charging rech. batteries of up to 18 devices
- Average charging time, depending on condition of rechargeable batteries used: approx. 8 hours
- Each slot with LED for indicating battery charging status

Model	TG-10CH18
Suitable for	18 x TG-10T/1, TG-10R/1, KA-10 components
Power supply	via encl. switch-mode power supply
Dimensions	361 x 422 x 189 mm
Weight	3.26 kg

- Mechanical reverse polarity protection
- Protection against overload, short-circuit and deep discharge

Supplied w/o devices.



TG-64CH18

Order No. 0259620

Transport case with integrated charging function, for transmitters and receivers of the TG-98 series as well as the TG-16 series.

- For simultaneously charging rech. batteries of up to 18 devices
- Average charging time, depending on condition of rechargeable batteries used: approx. 8 hours
- Each slot with LED for indicating battery charging status
- Mechanical reverse polarity protection

Model	TG-64CH18
Description	transport case with charging function
Colour	black
Suitable for	18 x TG-98RA/5, TG-98TA/5, TG-16RA/1, TG-16TA/1
Power supply	via encl. switch-mode power supply
Dimensions	362 x 422 x 189 mm
Weight	3.3 kg

- Protection against overload, short-circuit and deep discharge

Supplied w/o devices.



TG-10CH36

Order No. 0252680

Transport case with castors and integrated charging function, for transmitters TG-10T/1 and receivers TG-10R/1 as well as for KA-10 components.

- For simultaneously charging rech. batteries of up to 36 devices
- Average charging time, depending on condition of rechargeable batteries used: approx. 8 hours
- Each slot with LED for indicating battery charging status
- Mechanical reverse polarity protection
- Protection against overload, short-circuit and deep discharge
- Hard-sided plastic transport case with carrying handle
- Due to the integrated telescopic handle and 4 castors, the transport case can easily be pulled like a trolley
- Can be locked via key

Model	TG-10CH36
Suitable for	36 x TG-10T/1, TG-10R/1, KA-10 components
Power supply	via encl. switch-mode power supply
Dimensions	400 x 561 x 230 mm
Weight	7.3 kg





You can also look forward to these new products in 2020:



RU-901DU
2-channel UHF PLL Receiver



CM-501HI
Condenser Lavalier Microphone

8	CX-516..... J32	MA-935..... J4	TG-10T/1..... J60
801C3..... J29	CX-516W..... J32	MA-HPF..... J49	TG-64CH18..... J62
801C3/B..... J29	CX-520..... J32	MA-PRS..... J49	TG-98RA/5..... J59
801C4..... J29		MA-SW..... J48	TG-98TA/5..... J59
801C4/B..... J29	D	MH-16..... J49	TK-350..... J35
801CR..... J29	D7P-10..... J55	MH-22..... J49	TK-600..... J35
801CR/B..... J29	D7P-20..... J55	MH-36..... J49	TM-929..... J36
801CS..... J29	DR-900SET..... J20	MH-56..... J49	TM-969..... J35
801CS/B..... J29		MH-850/1..... J16	TM-989..... J35
850CH-2..... J12	E	MH-8800G/5..... J9	
	E-7BPSET/5..... J15		U
A	E-7BPSETD/5..... J15	N	UA-960..... J20
ANT-49..... J19	E-7DU/5..... J14	NM-43..... J28	UB-900I..... J20
	E-7HHSET/5..... J15	NX-2..... J33	UC-900..... J20
B	E-7HHSETD/5..... J15	NX-6..... J33	UDA-49A..... J19
BAG-ARM/L..... J22	E-7R/5..... J14	NX-8..... J34	UDA-49P..... J19
BAG-ARM/S..... J61	E-7TB/5..... J14	NX-8.8..... J34	UF-20R/5..... J3
BAG-BELT/L..... J22	E-7TBD/5..... J14	NX-8S..... J34	UF-20S/5..... J3
BAG-BELT/S..... J61	E-7TH/5..... J14	NX-9..... J33	UF-20TB/5..... J4
	E-7THD/5..... J14		US-8001D/1..... J16
C	F	P	US-8001DB/5..... J17
CH-2..... J7, J4	FGM-170..... J45	PDM-3..... J36	US-8001DBGY/5..... J17
CH-8..... J4	FGM-170T..... J45	PDM-57..... J39	US-8002D/1..... J16
CLP-6..... J49	FGM-62..... J45	PS-500..... J48	US-903DCPRO/5..... J9
CM-125IB..... J29	FGM-62T..... J45	PS-510M..... J48	USP-124..... J20
CM-125IF..... J29		PT-850B/1..... J17	USP-900..... J19
CM-214F..... J27	G	PT-920BG/5..... J9	
CM-214ULF..... J27	G3CH-2..... J8	PT-RMS..... J28	W
CM-22G12B..... J40	GC-80..... J49		W4-CH1..... J53
CM-22G12W..... J40	GM-5212..... J44	R	W4-CH12..... J53
CM-22G6B..... J40	GM-5212DU..... J43	R-4/5..... J6	W4-CH12/COVER..... J53
CM-22G6W..... J40	GM-5212L..... J44	R-4TBM/5..... J7	WA-35..... J36
CM-235IB..... J27	GM-5212LDU..... J43	R-4THA/5..... J6	
CM-235IF..... J27	GM-5215DU..... J43	RM-10SET..... J22	
CM-501..... J28	GM-5218..... J44	RM-901..... J22	
CM-502..... J39	GM-5218L..... J44	RP-900..... J20	
CM-502G12B..... J40	GML-5212..... J44	RTF-1..... J21	
CM-502G12W..... J40	GML-5218..... J44	RTF-20..... J21	
CM-502G6B..... J40		RTF-2U..... J21	
CM-502G6W..... J40	H	RTF-3..... J21	
CM-502WT..... J39	HP-535..... J37	RU-8011DB/5..... J11	
CM-503N/B..... J45	HP-565..... J37	RU-8012DB/5..... J11	
CM-503N/W..... J45	HPM-535..... J37	RU-850LTB/5..... J12	
CM-503U/B..... J45	HSE-300/SK..... J27	RU-850LTH/5..... J12	
CM-503U/W..... J45		RU-901G3/5..... J8	
CM-601..... J41	I	RU-G3TB/5..... J8	
CM-602..... J41	IE-1..... J25	RU-G3TH/5..... J8	
CM-602USB..... J41	IE-5..... J25		S
CM-801F..... J28	IT-12D..... J57	SGM-14..... J39	
CM-804IF..... J28	IT-12M..... J57	SIEM-111/5..... J24	
CP-40..... J36		SIEM-111/R5..... J24	
CS-1CH..... J55	J	SIEM-2/5..... J24	
CS-1CU..... J54	JS-1E..... J34	SIEM-2/R5..... J25	
CS-1DU..... J55	JS-22..... J39	ST-5000..... J46	
CS-4..... J56	JSS-20/5..... J3	ST-5000T..... J46	
CS-8..... J56	JSS-4B/5..... J6	ST-5030..... J46	
CS-W4C/5..... J52		ST-5070..... J46	
CS-W4T/5..... J52	K	ST-850..... J46	
CX-500..... J31	KA-10/1PACK..... J61		T
CX-500DUSET..... J31	KA-8TH/1..... J61	TG-10CH18..... J62	
CX-500F..... J31		TG-10CH2..... J62	
CX-500FHW..... J31	M	TG-10CH36..... J62	
CX-505..... J32	MA-123..... J48	TG-10R/1..... J60	
CX-508..... J32	MA-500..... J48	TG-10STX/1..... J60	
CX-508W..... J32			
CX-509..... J39			

All products of MONACOR INTERNATIONAL are tested continuously to ensure a constant quality level and to maintain quality standards. All products which are subject to the CE guidelines as well as the electric and electronic subassemblies which are subject to the directive for motor vehicles are tested according to the respective standards and carry the CE mark. These products can thus be sold in all EC countries without further tests or approvals.

General Information

- All rights reserved by MONACOR INTERNATIONAL GmbH & Co. KG. All contents of this catalogue serve as information as to the products by MONACOR INTERNATIONAL only. No part of this catalogue including text, photos of products, graphics - or any parts thereof - may be reproduced in any form or by any means for any commercial use without our express prior written consent.
- *Windows is a registered trademark of Microsoft Corporation in the United States and other countries.
- The software available on our websites is partly an 'Open Source Software' which is licenced under 'General Public License' (GPL). Further information can be found at the following link: <http://www.gnu.org/licenses/>.
- HDMI™ is a registered trademark of HDMI Licensing L.L.C.
- We cannot be held responsible for printing errors, should they occur. We reserve the right to make technical changes without prior notice.
- Specifications stated are according to information provided by the manufacturer.
- Due to production tolerances, technical data may vary slightly.
- Damage resulting from unauthorised servicing of the products thus causing changes as well as improper handling resulting in consequential damage are excluded from the warranty. We will not be liable for changes of the state of the products resulting from improper storage, other interventions or improper use.
- Lithium batteries have to meet special regulations for transportation and storage. Before dispatching such products, please pay attention to the safety notes in the section 'Downloads' on our website.
- If the devices are interfered with, the CE approval will no longer apply. All products are usually suitable for indoor use only, unless stated otherwise. The products are not suitable for installations into aircrafts or for surface mounting onto aircrafts.
- The devices do not correspond to the medical products directive 2007/47/EC.
- If the devices are permanently taken out of operation, they must be taken to a local recycling plant for disposal which is not harmful to the environment.

Technical Information

- Before first use of the products, please read the instruction manual carefully!
- The products correspond to the directive for electromagnetic compatibility 2014/30/EU, the directive 2011/65/EU (RoHS) with the addition EU/2015/863 and where applicable to the low voltage directive 2014/35/EU with the directive 2009/125/EC (ErP) and the regulation 2019/1782.
- When operating with voltages of over 42 V, please always follow respective safety measures.
- Before opening any product operated with 230 V mains voltage, disconnect device from the mains.
- Make sure that the supply voltage is disconnected before working on components and modules. Existing capacitors must be discharged.
- Mains cables and test cables must be checked for damage on a regular basis. Never pull on the cable to disconnect the plug from the socket.
- Mains cables and fuses must only be replaced by skilled personnel.
- Unless otherwise stated:
 - protect the products from moisture and heat,
 - always observe the admissible ambient temperature of 0-40 °C.
- Do not use a very high volume level when using headphones. Permanent high volume may damage your hearing! Do not wear headphones while particular attention must be paid to your surroundings, e.g. in traffic.
- A soldering process which is too long and too hot may cause damage to the corresponding products. Choose a soldering temperature that is suitable for the material used. No liability can be assumed for damage to the product or consequential damage caused by improper handling.
- The plugs, jacks, switches, rotary switches and potentiometers shown in this catalogue are only suitable for connection to safety extra low voltage (SELV) or signal voltage unless the item is designed for a higher voltage (see text or table).
- If the fixing nuts of panel jacks or panel plugs are overtightened, it may cause damage to the whole component. In case of improper handling, no liability can be assumed for this or any consequential damage.
- The heat must be eliminated by air circulation. Therefore, do not cover ventilation slots with anything. Do not put or drop anything through the ventilation slots. Otherwise, there will be danger of an electric shock.
- Only use a dry, soft cloth for cleaning the products. Chemicals must not be used in any case.
- LED lights and LED lamps contain various components which may generate noise in unfavourable conditions. There may be audible resonances caused by installation, design of the lamp and the base as well as dimmer or transformer.

Notes on Devices with Network/Internet Access

Please note that each device connected to a network with Internet access is part of a worldwide network. In order to protect your privacy and to prevent unauthorised people accessing your network and the devices connected, please protect your login details with an individual password prior to initial installation. Please take this into consideration when assigning future passwords in connection with devices, software and apps available in the network, e.g. when setting up user accounts. Passwords should never be disclosed to third parties! Furthermore, please note that any device which has been connected to the network should be reset before being sold or disposed of. This is the only way to ensure that all your personal data is erased permanently.

Information on the German Product Liability Act

According to the law dated 15 December 1989 governing product liability which was last amended by the law dated 19 July 2002, manufacturers, importers and retailers are obliged to compensate for damage caused by a faulty product under certain prerequisites.

A product can already be considered faulty if its presentation leaves a private, non-commercial end user with a wrong impression as to its safety in use or if it is to be expected that the private end user will not observe the required safety regulations when using the product or will apply an excessive operating voltage to it, except if this user has been informed as to the necessity to observe the safety regulations and specified voltages, etc.

In your own interest and for your customers' safety, therefore please draw your non-commercial customers' attention to the following:

The products listed in this catalogue may only be used for the stated purpose. If there are any doubts as to the purpose of the goods, questions must be clarified with an authorised expert or with the service department of MONACOR INTERNATIONAL.

The following EN standards and VDE (Verband Deutscher Elektrotechniker = Association of German Electrical Engineers) regulations must be observed:

Electromagnetic Compatibility:

EN300422, EN301489, EN55013, EN55103-1, EN55103-2, EN61000-3-2, EN61000-3-3, EN61000-6-1, EN61000-6-3

Low Voltage Directive:

DIN VDE 0100, DIN VDE 0532, EN60065, EN60335, EN60598, EN60950, EN61010, EN62471

Motor Vehicles Directive:

Directive 2004/104/EC

In Germany, the above-mentioned regulations can be obtained from:

VDE-Verlag GmbH Bismarckstraße 33 10625 Berlin Germany Phone: +49 30 348001-0 Fax: +49 30 348001-9088	VDE-Verlag GmbH Postfach 120143 10591 Berlin Germany Phone: +49 30 348001-0 Fax: +49 30 348001-9088	VDE-Verlag GmbH Goethering 58 63067 Offenbach Germany Phone: +49 69 840006-0 Fax: +49 69 840006-1399
--	--	---

Notes Regarding the Approval of Wireless Systems

The wireless microphone systems in the frequency ranges 863 MHz to 865 MHz and 2,400 MHz are generally approved and licence-free. These wireless systems are licence-free in the EU.

Every wireless system has been examined by a notified body and has been approved in the EU according to the RED directive. However, a frequency assignment for the systems in the frequency range 506 MHz to 542 MHz, 518 MHz to 542 MHz, 672 MHz to 697 MHz and 740 MHz to 776 MHz, 823 MHz to 832 MHz and 1.8 GHz for the corresponding area in which the device is to be used must be applied for at the respective national authority. There are restrictions or requirements within the EU!

In Germany, the frequency assignment has to be applied for at the corresponding branch of the Federal Network Agency (BNetzA, Germany).

The declaration of conformity can be found on our website: www.monacor.com, www.imgstageline.com or www.jts-europe.com. The forms for the frequency assignment can be found on the website of the Federal Network Agency www.bundesnetzagentur.de. For countries outside of Europe, please consult the authorities of the corresponding country.

Please observe the notes in the operating instructions.

MONACOR INTERNATIONAL GmbH & Co. KG; February 2020

MONACOR INTERNATIONAL - Your reliable partner - worldwide.

JTS®

Headquarters MONACOR INTERNATIONAL

Zum Falsch 36 | 28307 Bremen | Germany

Phone: +49 421 4865-0

Fax: +49 421 488415

info@monacor.com | www.monacor-international.com

K-1153.02.01.03.2020

K20-198JTSEN

Best.-Nr. 1000050



Distributed by



Your retailer

www.jts-europe.com